



www.seachrome.com

# Price List

## August 2024



1(310)427-8010 / 1(800)955-2476



1(310)427-8005 / 1(800)444-3380



1906 E Dominguez St., Long Beach, CA 90810



# TABLE OF CONTENTS

## GRAB BARS

|  |       |
|--|-------|
| Signature Series - Grab Bar Flange Designs .....                                     | 3     |
| Signature Series - Value Line Stainless Steel Grab Bars .....                        | 4     |
| Signature Series - Satin Stainless - Domestic Grab Bars .....                        | 5-7   |
| Signature Series - Decorative Finishes Stainless - Domestic Grab Bars .....          | 8-9   |
| Signature Series - Powder Coat - Polished Brass & Stainless Domestic Grab Bars ..... | 10    |
| Signature Series - Bariatric Grab Bars .....   | 11    |
| Signature Series - Institutional Ligature Resistant Grab Bars .....                  | 11    |
| Lifestyle & Wellness® Series - Grab Bars .....                                       | 12-13 |
| Coronado Series - Grab Bars .....  | 14-15 |

## TUB/SHOWER SEATS

|  |       |
|--|-------|
| Signature Series - ADA Accessibility Shower Seats .....                                | 16-17 |
| Signature Series - Portable Free Standing Seats, Bariatric & Institutional Seats ..... | 18    |
| Signature Series - Stationary Benches - Shower Seat Component Items .....              | 19    |
| Signature Series - Tub Seats .....   | 20    |
| Lifestyle & Wellness® Series - Tub & Shower Seats.....                                 | 21    |
| Lifestyle & Wellness® Series - Silhouette Shower Seats .....                           | 22-24 |
| Lifestyle & Wellness® Series - Silhouette Seat Pads .....                              | 24    |

## BATH ACCESSORIES

|   |       |
|---|-------|
| Lifestyle & Wellness® Series - Shower Shelves .....             | 25    |
| Signature Series - Shower Shelves .....                         | 26    |
| Signature Series - Shower Rods, Flanges, Curtains & Rings ..... | 27-28 |
| Coronado Series - Bathroom Accessories - 700 & 711 Series ..... | 29-30 |
| Bath Accessories - 15000 Series Stainless Steel .....           | 31    |
| Bath Accessories - Contemporary .....                           | 32    |
| CAL Series - Commercial Washroom Accessories .....              | 33    |
| Terms and Conditions .....                                      | 34    |



Note: Throughout the Price Book, you will frequently encounter QR codes like the one displayed here. You can simply use your phone to scan these codes to access a product highlight video.

**SIGNATURE SERIES GRAB BARS**

MADE IN THE U.S.A



ALL "EW" & "CR" FLANGE, STAINLESS BARS MEET FEDERAL SPECIFICATION WW-P-541/8b, AMENDMENT 1, 16 APRIL 1990; ANSI 117.1, & ALL A.D.A. (Americans with Disabilities Act) CODE REQUIREMENTS.

THESE BARS, WHEN PROPERLY INSTALLED, MEET THE DOWNWARD PULL REQUIREMENT FOR FEDERAL SPECIFICATION WORK, F.H.A., V.A., HOSPITAL CODES & PRIVATE CONSTRUCTION.

**FLANGE CONFIGURATIONS**

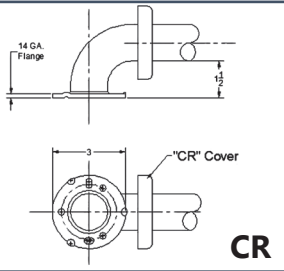

CONCEALED SCREW FLANGES

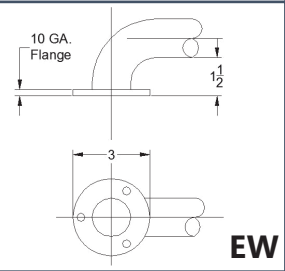

EXPOSED SCREW FLANGES

**MATERIAL & FINISH SERIES**

- "GS" - Satin #304 Stainless Steel
- "GX" - Polished #304 Stainless Steel
- "GY" - Peened with Satin Ends #304 Stainless Steel
- "GZ" - Peened with Polished Ends #304 Stainless Steel
- "GB" - Polished #260 Solid Brass
- "GP" Powder Coated #304 Stainless Steel

**BAR DIAMETERS**

- "H" 1-1/2" diameter x .049" (18 gauge)
- "Q" 1-1/4" diameter x .049" (18 gauge)

**STANDARD WALL CLEARANCE**

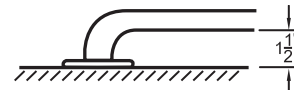

**TO ORDER - SPECIFY**

| EXAMPLE           | SERIES | CONFIGURATION | DIMENSION | BAR DIAMETER | FLANGE |
|-------------------|--------|---------------|-----------|--------------|--------|
| GST-240360-HCR2 = | GS +   | T +           | 240360 +  | H +          | CR2    |

**DECORATIVE CONCEALED FLANGE COVERS**

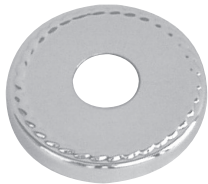

ROPE "2"



RIDGE "3"



STEP "4"



BAND "5"

Add \$5.00 list per flange.

Seachrome includes  
6 - #10 x 2-1/2"  
Stainless Steel Phillips  
Head mounting screws  
packaged with each  
grab bar.

SEACHROME SPECIALIZES IN CUSTOM SIZES & CONFIGURATIONS

\*\* PLEASE CALL FOR TECHNICAL ASSISTANCE & COMPETITIVE PRICE QUOTES \*\*

**SIGNATURE SERIES - VALUE LINE - STAINLESS STEEL GRAB BARS**

**VALUE LINE STAINLESS STEEL GRAB BARS**

Fabricated using #304 Stainless Steel with concealed flanges, our **VALUE LINE SERIES** satisfies ADA Guidelines & Federal Specification WW-P-541/8b.

Our **VALUE LINE SERIES** of Grab Bars will satisfy every ADA project & budget.



SATIN FINISH  
IGSS-120-QCR



POLISHED FINISH  
IGXS-120-QCR



PEENED WITH SATIN ENDS  
IGYS-120-QCR



PEENED WITH POLISHED ENDS  
IGZS-120-QCR

| "H" 1-1/2" TUBE DIAMETER               |      |       |
|--|------|-------|
| SATIN STAINLESS / 'IGSS' Series        |      |       |
| ITEM#                                  | SIZE | LIST  |
| IGSS-120-HCR                           | 12"  | 28.70 |
| IGSS-160-HCR                           | 16"  | 30.05 |
| IGSS-180-HCR                           | 18"  | 30.75 |
| IGSS-240-HCR                           | 24"  | 35.00 |
| IGSS-300-HCR                           | 30"  | 37.65 |
| IGSS-320-HCR                           | 32"  | 40.15 |
| IGSS-360-HCR                           | 36"  | 43.10 |
| IGSS-420-HCR                           | 42"  | 46.15 |
| IGSS-480-HCR                           | 48"  | 52.70 |
| POLISHED / 'IGXS' Series               |      |       |
| IGXS-120-HCR                           | 12"  | 39.80 |
| IGXS-160-HCR                           | 16"  | 42.55 |
| IGXS-180-HCR                           | 18"  | 44.00 |
| IGXS-240-HCR                           | 24"  | 48.50 |
| IGXS-300-HCR                           | 30"  | 54.55 |
| IGXS-320-HCR                           | 32"  | 55.80 |
| IGXS-360-HCR                           | 36"  | 59.45 |
| IGXS-420-HCR                           | 42"  | 64.20 |
| IGXS-480-HCR                           | 48"  | 68.85 |
| PEENED WITH SATIN ENDS / 'IGYS' Series |      |       |
| IGYS-120-HCR                           | 12"  | 35.95 |
| IGYS-160-HCR                           | 16"  | 38.45 |
| IGYS-180-HCR                           | 18"  | 39.50 |
| IGYS-240-HCR                           | 24"  | 45.00 |
| IGYS-300-HCR                           | 30"  | 49.40 |
| IGYS-320-HCR                           | 32"  | 51.20 |
| IGYS-360-HCR                           | 36"  | 54.30 |
| IGYS-420-HCR                           | 42"  | 57.00 |
| IGYS-480-HCR                           | 48"  | 62.15 |

| "Q" 1-1/4" TUBE DIAMETER               |      |       |
|--|------|-------|
| SATIN STAINLESS / 'IGSS' Series        |      |       |
| ITEM#                                  | SIZE | LIST  |
| IGSS-120-QCR                           | 12"  | 25.85 |
| IGSS-160-QCR                           | 16"  | 26.60 |
| IGSS-180-QCR                           | 18"  | 29.15 |
| IGSS-240-QCR                           | 24"  | 31.20 |
| IGSS-300-QCR                           | 30"  | 33.70 |
| IGSS-320-QCR                           | 32"  | 35.65 |
| IGSS-360-QCR                           | 36"  | 37.25 |
| IGSS-420-QCR                           | 42"  | 43.25 |
| IGSS-480-QCR                           | 48"  | 47.50 |
| POLISHED / 'IGXS' Series               |      |       |
| IGXS-120-QCR                           | 12"  | 37.55 |
| IGXS-160-QCR                           | 16"  | 42.30 |
| IGXS-180-QCR                           | 18"  | 43.60 |
| IGXS-240-QCR                           | 24"  | 45.40 |
| IGXS-300-QCR                           | 30"  | 50.85 |
| IGXS-320-QCR                           | 32"  | 51.80 |
| IGXS-360-QCR                           | 36"  | 55.05 |
| IGXS-420-QCR                           | 42"  | 59.40 |
| IGXS-480-QCR                           | 48"  | 63.30 |
| PEENED WITH SATIN ENDS / 'IGYS' Series |      |       |
| IGYS-120-QCR                           | 12"  | 32.30 |
| IGYS-160-QCR                           | 16"  | 36.05 |
| IGYS-180-QCR                           | 18"  | 37.65 |
| IGYS-240-QCR                           | 24"  | 38.45 |
| IGYS-300-QCR                           | 30"  | 47.20 |
| IGYS-320-QCR                           | 32"  | 48.75 |
| IGYS-360-QCR                           | 36"  | 51.90 |
| IGYS-420-QCR                           | 42"  | 52.85 |
| IGYS-480-QCR                           | 48"  | 56.60 |

| "Q" 1-1/4" TUBE DIAMETER                  |      |       |
|---|------|-------|
| PEENED WITH POLISHED ENDS / 'IGZS' Series |      |       |
| ITEM#                                     | SIZE | LIST  |
| IGZS-120-QCR                              | 12"  | 40.85 |
| IGZS-160-QCR                              | 16"  | 43.50 |
| IGZS-180-QCR                              | 18"  | 44.65 |
| IGZS-240-QCR                              | 24"  | 49.25 |
| IGZS-300-QCR                              | 30"  | 54.85 |
| IGZS-320-QCR                              | 32"  | 56.10 |
| IGZS-360-QCR                              | 36"  | 59.40 |
| IGZS-420-QCR                              | 42"  | 68.15 |
| IGZS-480-QCR                              | 48"  | 73.85 |

**SIGNATURE SERIES GRAB BARS - SATIN STAINLESS - DOMESTIC GRAB BARS**

MADE IN THE U.S.A

**GRAB BAR OPTIONS**

- QEW 1-1/4" BAR DIAMETER WITH EXPOSED FLANGE
- HEW 1-1/2" BAR DIAMETER WITH EXPOSED FLANGE
- QCR 1-1/4" BAR DIAMETER WITH CONCEALED FLANGE
- HCR 1-1/2" BAR DIAMETER WITH CONCEALED FLANGE

HEW



1-1/2" BAR DIAMETER WITH EXPOSED FLANGE

QCR



1-1/4" BAR DIAMETER WITH CONCEALED FLANGE

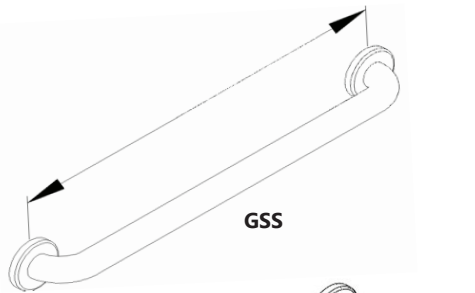

GSS

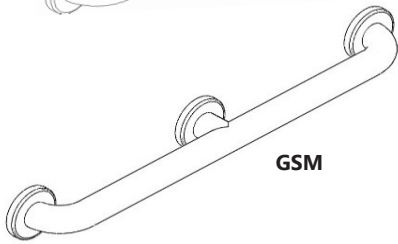

GSM

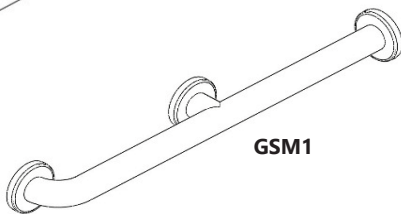

GSM1

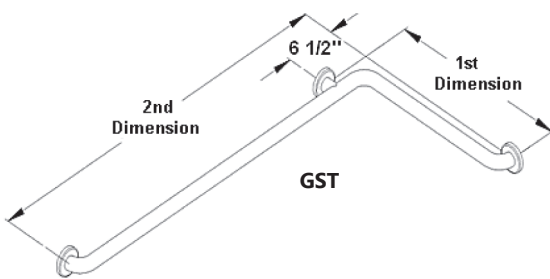

GST

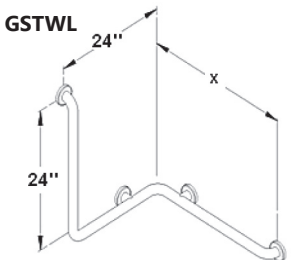

Left-Handed Shown

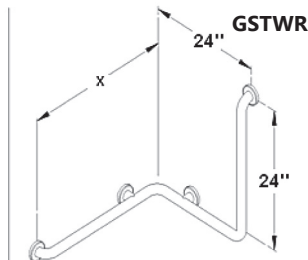

Right-Handed Shown

**"S" STRAIGHT BARS**

| ITEM#   | LENGTH | QEW   | HEW   | QCR   | HCR   |
|---------|--------|-------|-------|-------|-------|
| GSS-120 | 12"    | 53.80 | 58.75 | 54.75 | 59.95 |
| GSS-160 | 16"    | 56.70 | 59.85 | 57.70 | 60.90 |
| GSS-180 | 18"    | 58.75 | 62.30 | 59.95 | 63.35 |
| GSS-240 | 24"    | 63.35 | 70.50 | 64.50 | 71.75 |
| GSS-300 | 30"    | 68.85 | 74.35 | 70.40 | 75.75 |
| GSS-320 | 32"    | 72.85 | 78.70 | 74.35 | 80.20 |
| GSS-360 | 36"    | 75.40 | 82.90 | 76.80 | 84.55 |
| GSS-420 | 42"    | 81.45 | 86.90 | 82.90 | 86.90 |
| GSS-480 | 48"    | 85.05 | 93.60 | 86.60 | 95.35 |

**"M" STRAIGHT BARS WITH CENTER POST (GSM & GSM1)**

| ITEM#   | LENGTH | QEW    | HEW    | QCR    | HCR    |
|---------|--------|--------|--------|--------|--------|
| GSM-360 | 36"    | 96.80  | 105.75 | 96.80  | 105.75 |
| GSM-420 | 42"    | 112.85 | 117.45 | 112.85 | 117.45 |
| GSM-480 | 48"    | 117.30 | 127.25 | 117.30 | 127.25 |
| GSM-520 | 52"    | 121.60 | 133.15 | 121.60 | 133.15 |
| GSM-540 | 54"    | 124.75 | 135.35 | 124.75 | 135.35 |
| GSM-600 | 60"    | 129.75 | 142.55 | 129.75 | 142.55 |

**"T" TUB & SHOWER BARS (REVERSIBLE)**

| ITEM#      | LENGTH    | QEW    | HEW    | QCR    | HCR    |
|------------|-----------|--------|--------|--------|--------|
| GST-160160 | 16" x 16" | 141.80 | 167.30 | 141.80 | 167.30 |
| GST-160320 | 16" x 32" | 149.85 | 172.45 | 149.85 | 172.45 |
| GST-240240 | 24" x 24" | 149.85 | 172.45 | 149.85 | 172.45 |
| GST-200400 | 20" x 40" | 165.10 | 195.50 | 165.10 | 195.50 |
| GST-240360 | 24" x 36" | 165.10 | 195.50 | 165.10 | 195.50 |
| GST-240480 | 24" x 48" | 182.55 | 211.30 | 182.55 | 211.30 |
| GST-300300 | 30" x 30" | 165.10 | 195.50 | 165.10 | 195.50 |
| GST-360360 | 36" x 36" | 182.55 | 211.30 | 182.55 | 211.30 |
| GST-360480 | 36" x 48" | 199.30 | 225.05 | 199.30 | 225.05 |
| GST-360540 | 36" x 54" | 207.45 | 232.10 | 207.45 | 232.10 |

**"2 WAY" TUB/SHOWER BAR \*(SPECIFY LH or RH)**

| ITEM#              | LENGTH          | QEW    | HEW    | QCR    | HCR    |
|--------------------|-----------------|--------|--------|--------|--------|
| GSTW* (L/R)-360240 | 36" x 24" x 24" | 376.30 | 394.70 | 376.30 | 394.70 |
| GSTW* (L/R)-480240 | 48" x 24" x 24" | 413.45 | 431.60 | 413.45 | 431.60 |
| GSTW* (L/R)-540240 | 54" x 24" x 24" | 432.90 | 451.70 | 432.90 | 451.70 |

**SIGNATURE SERIES GRAB BARS - SATIN STAINLESS - DOMESTIC GRAB BARS**

MADE IN THE U.S.A

**GRAB BAR OPTIONS**

|     |   |
|-----|---|
| QEW | 1-1/4" BAR DIAMETER WITH EXPOSED FLANGE   |
| HEW | 1-1/2" BAR DIAMETER WITH EXPOSED FLANGE   |
| QCR | 1-1/4" BAR DIAMETER WITH CONCEALED FLANGE |
| HCR | 1-1/2" BAR DIAMETER WITH CONCEALED FLANGE |

HEW



1-1/2" BAR DIAMETER WITH EXPOSED FLANGE

QCR



1-1/4" BAR DIAMETER WITH CONCEALED FLANGE

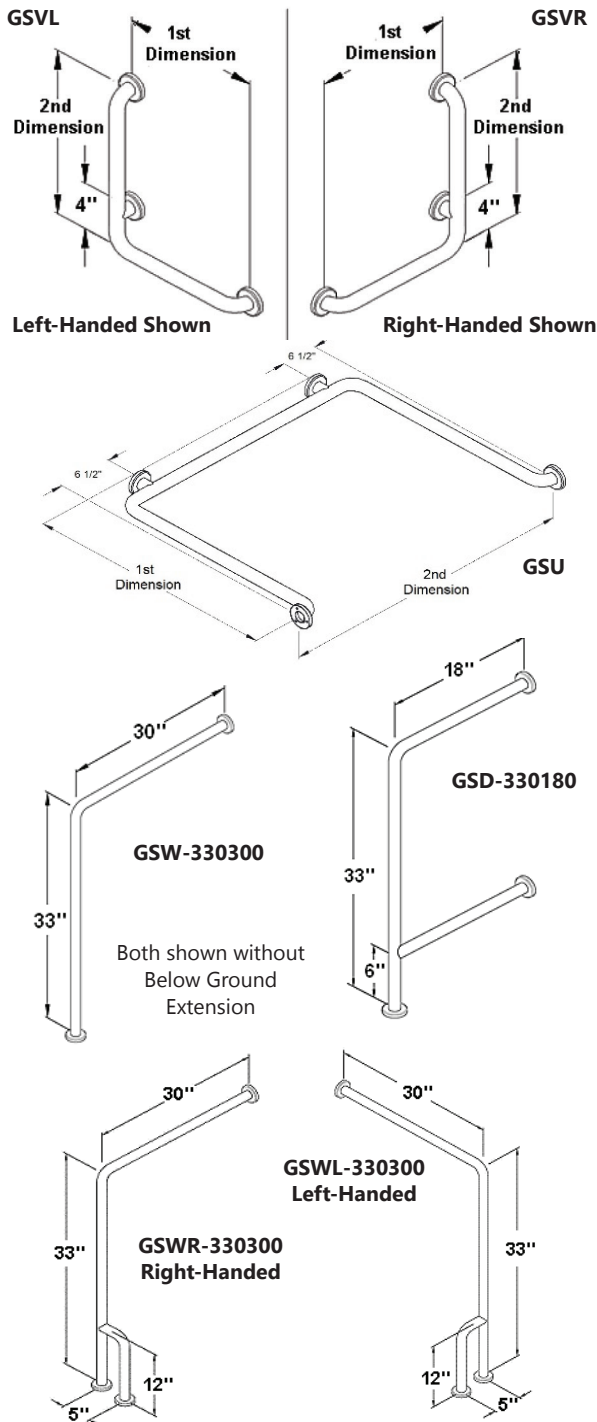

**"V" VERTICAL ANGLE BARS \*(DESIGNATE LH or RH)**

| ITEM#             | LENGTH    | QEW    | HEW    | QCR    | HCR    |
|-------------------|-----------|--------|--------|--------|--------|
| GSV* (L/R)-160160 | 16" x 16" | 141.80 | 167.30 | 141.80 | 167.30 |
| GSV* (L/R)-200200 | 20" x 20" | 144.50 | 170.15 | 144.50 | 170.15 |
| GSV* (L/R)-240240 | 24" x 24" | 149.85 | 172.45 | 149.85 | 172.45 |
| GSV* (L/R)-300300 | 30" x 30" | 165.10 | 195.55 | 165.10 | 195.55 |
| GSV* (L/R)-160320 | 16" x 32" | 149.85 | 172.45 | 149.85 | 172.45 |

**"U" U-SHAPED SHOWER BARS**

| ITEM#      | LENGTH          | QEW    | HEW    | QCR    | HCR    |
|------------|-----------------|--------|--------|--------|--------|
| GSU-300360 | 30" x 36" x 30" | 347.15 | 365.60 | 347.15 | 365.60 |
| GSU-300480 | 30" x 48" x 30" | 365.60 | 381.85 | 365.60 | 381.85 |
| GSU-300540 | 30" x 54" x 30" | 381.90 | 400.35 | 381.90 | 400.35 |
| GSU-300600 | 30" x 60" x 30" | 404.85 | 423.60 | 404.85 | 423.60 |

**"D" DRINKING FOUNTAIN BAR -WITHOUT BELOW GROUND EXTENSION**

| ITEM#      | LENGTH    | QEW    | HEW    | QCR    | HCR    |
|------------|-----------|--------|--------|--------|--------|
| GSD-330180 | 33" x 18" | 202.75 | 217.15 | 202.75 | 196.30 |

**"D" DRINKING FOUNTAIN BAR -WITH BELOW GROUND EXTENSION**

| ITEM#        | LENGTH    | QEW    | HEW    | QCR    | HCR    |
|--------------|-----------|--------|--------|--------|--------|
| GSDBG-330180 | 33" x 18" | 184.25 | 196.30 | 184.25 | 217.15 |

**"W" WALL-TO-FLOOR BAR -WITHOUT BELOW GROUND EXTENSION**

| ITEM#      | LENGTH    | QEW    | HEW    | QCR    | HCR    |
|------------|-----------|--------|--------|--------|--------|
| GSW-330300 | 33" x 30" | 157.25 | 185.00 | 157.25 | 185.00 |

**"W" WALL-TO-FLOOR BAR -WITH BELOW GROUND EXTENSION**

| ITEM#        | LENGTH    | QEW    | HEW    | QCR    | HCR    |
|--------------|-----------|--------|--------|--------|--------|
| GSWBG-330300 | 33" x 30" | 168.25 | 195.55 | 168.25 | 195.55 |

**"WL" (LH) / "WR" (RH) WALL-TO-FLOOR BARS WITH SIDE LEG**

| ITEM#       | LENGTH    | QEW    | HEW    | QCR    | HCR    |
|-------------|-----------|--------|--------|--------|--------|
| GSWL-330300 | 33" x 30" | 261.40 | 289.85 | 261.40 | 289.85 |
| GSWR-330300 | 33" x 30" | 261.40 | 289.85 | 261.40 | 289.85 |

**SIGNATURE SERIES GRAB BARS - SATIN STAINLESS - DOMESTIC GRAB BARS**

MADE IN THE U.S.A

**GRAB BAR OPTIONS**

- QEW 1-1/4" BAR DIAMETER WITH EXPOSED FLANGE
- HEW 1-1/2" BAR DIAMETER WITH EXPOSED FLANGE
- QCR 1-1/4" BAR DIAMETER WITH CONCEALED FLANGE
- HCR 1-1/2" BAR DIAMETER WITH CONCEALED FLANGE



HEW  
1-1/2" BAR DIAMETER WITH EXPOSED FLANGE



QCR  
1-1/4" BAR DIAMETER WITH CONCEALED FLANGE

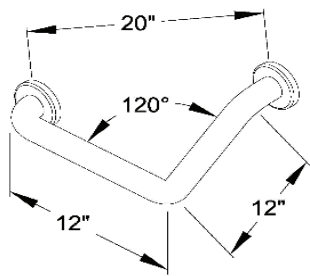

**GSB-120120**

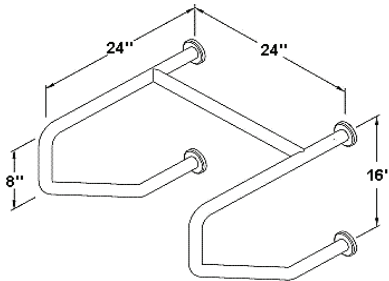

**GSWW-240240**

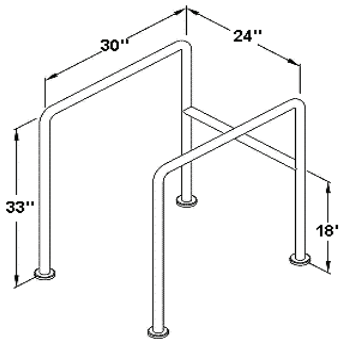

**GSFS-330300**

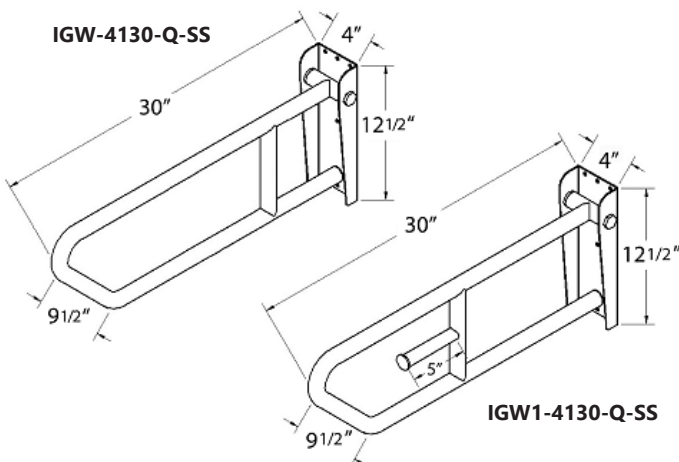

**IGW-4130-Q-SS**

**IGW1-4130-Q-SS**

**BOOMERANG**

| ITEM#      | LENGTH    | QEW   | HEW    | QCR   | HCR    |
|------------|-----------|-------|--------|-------|--------|
| GSB-120120 | 12" x 12" | 92.25 | 100.70 | 92.25 | 100.70 |

**WALL TO WALL STRADDLE**

| ITEM#      | LENGTH    | QEW    | HEW    | QCR    | HCR    |
|------------|-----------|--------|--------|--------|--------|
| GWW-240240 | 24" x 24" | 447.65 | 467.65 | 447.65 | 467.65 |

**FLOOR TO FLOOR STRADDLE**

| ITEM#       | LENGTH    | QEW    | HEW    | QCR    | HCR    |
|-------------|-----------|--------|--------|--------|--------|
| GSFS-330300 | 33" x 30" | 621.25 | 649.00 | 621.30 | 649.00 |

**IMPORT SWING-UP GRAB BAR - 30" OVERALL**

| ITEM#     | LENGTH                             | Q-SS (SATIN) |
|-----------|------------------------------------|--------------|
| IGW-4130  | 30" x 9.5"                         | 174.20       |
| IGW1-4130 | 30" x 9.5" with Toilet Roll Holder | 208.50       |

**GRAB BARS: ADDITIONAL ITEMS**

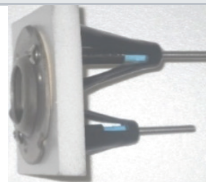

SCW-RESGBW35



SCW-GBW40

**WINGIT FASTENERS**

| ITEM#        | DESCRIPTION   | LIST PRICE   |
|--------------|---|--------------|
| SCW-RESGBW35 | GRAB BAR WINGIT FASTENER  | \$28.00 PAIR |
| SCW-GBW40    | COMMERCIAL STANDARD GRAB BAR WINGIT FASTENER ** (ALSO COMPATIBLE WITH 3" DIAMETER WITH 3 HOLE SHOWER SEAT FLANGE) | \$65.00 EACH |

**ADDITIONAL ITEMS**

| ITEM                                   | LIST PRICE   |
|--|--------------|
| SIDE LEG SUPPORT                       | \$82.50 EACH |
| QCR/HCR WALL MOUNT SUPPORT - GRAB BARS | \$60.00 EACH |
| STAINLESS STEEL WELDED END CAPS        | \$35.00 EACH |

**SIGNATURE SERIES GRAB BARS - DECORATIVE FINISHES STAINLESS - DOMESTIC GRAB BARS**  
**MADE IN THE U.S.A**

**"Q" 1-1/4" TUBE DIAMETER**



| POLISHED STAINLESS "GX" SERIES       |           |        |
|--------------------------------------|-----------|--------|
| "Q" 1-1/4" TUBE DIAMETER             |           |        |
| "S" STRAIGHT                         |           |        |
| ITEM#                                | SIZE      | LIST   |
| GXS-120-QCR                          | 12"       | 76.60  |
| GXS-160-QCR                          | 16"       | 87.30  |
| GXS-180-QCR                          | 18"       | 93.45  |
| GXS-240-QCR                          | 24"       | 110.20 |
| GXS-300-QCR                          | 30"       | 127.45 |
| GXS-320-QCR                          | 32"       | 135.35 |
| GXS-360-QCR                          | 36"       | 145.85 |
| GXS-420-QCR                          | 42"       | 163.60 |
| GXS-480-QCR                          | 48"       | 179.40 |
| "T" TUB & SHOWER                     |           |        |
| GXT-160160-QCR                       | 16" x 16" | 200.50 |
| GXT-160320-QCR                       | 16" x 32" | 233.05 |
| GXT-240240-QCR                       | 24" x 24" | 235.05 |
| GXT-200400-QCR                       | 20" x 40" | 271.95 |
| GXT-240360-QCR                       | 24" x 36" | 271.95 |
| GXT-240480-QCR                       | 24" x 48" | 308.40 |
| GXT-300300-QCR                       | 30" x 30" | 271.95 |
| GXT-360360-QCR                       | 36" x 36" | 308.40 |
| GXT-360480-QCR                       | 36" x 48" | 348.35 |
| GXT-360540-QCR                       | 36" x 54" | 366.35 |
| "V" VERTICAL ANGLE *(SPECIFY L or R) |           |        |
| GXV*-160160-QCR                      | 16" x 16" | 200.50 |
| GXV*-200200-QCR                      | 20" x 20" | 216.70 |
| GXV*-240240-QCR                      | 24" x 24" | 233.05 |
| GXV*-300300-QCR                      | 30" x 30" | 271.95 |
| GXV*-160320-QCR                      | 16" x 32" | 233.05 |

| PEENED WITH SATIN ENDS "GY" SERIES   |           |        |
|--------------------------------------|-----------|--------|
| "Q" 1-1/4" TUBE DIAMETER             |           |        |
| "S" STRAIGHT                         |           |        |
| ITEM#                                | SIZE      | LIST   |
| GYS-120-QCR                          | 12"       | 58.45  |
| GYS-160-QCR                          | 16"       | 64.90  |
| GYS-180-QCR                          | 18"       | 68.50  |
| GYS-240-QCR                          | 24"       | 84.20  |
| GYS-300-QCR                          | 30"       | 88.55  |
| GYS-320-QCR                          | 32"       | 93.75  |
| GYS-360-QCR                          | 36"       | 99.55  |
| GYS-420-QCR                          | 42"       | 110.30 |
| GYS-480-QCR                          | 48"       | 119.05 |
| "T" TUB & SHOWER                     |           |        |
| GYT-160160-QCR                       | 16" x 16" | 164.90 |
| GYT-160320-QCR                       | 16" x 32" | 183.30 |
| GYT-240240-QCR                       | 24" x 24" | 183.30 |
| GYT-200400-QCR                       | 20" x 40" | 210.45 |
| GYT-240360-QCR                       | 24" x 36" | 210.45 |
| GYT-240480-QCR                       | 24" x 48" | 235.70 |
| GYT-300300-QCR                       | 30" x 30" | 210.45 |
| GYT-360360-QCR                       | 36" x 36" | 235.70 |
| GYT-360480-QCR                       | 36" x 48" | 263.35 |
| GYT-360540-QCR                       | 36" x 54" | 276.40 |
| "V" VERTICAL ANGLE *(SPECIFY L or R) |           |        |
| GYV*-160160-QCR                      | 16" x 16" | 164.85 |
| GYV*-200200-QCR                      | 20" x 20" | 184.80 |
| GYV*-240240-QCR                      | 24" x 24" | 183.25 |
| GYV*-300300-QCR                      | 30" x 30" | 210.40 |
| GYV*-160320-QCR                      | 16" x 32" | 164.85 |

| PEENED WITH POLISHED ENDS "GZ" SERIES |           |        |
|---------------------------------------|-----------|--------|
| "Q" 1-1/4" TUBE DIAMETER              |           |        |
| "S" STRAIGHT                          |           |        |
| ITEM#                                 | SIZE      | LIST   |
| GZS-120-QCR                           | 12"       | 67.15  |
| GZS-160-QCR                           | 16"       | 73.30  |
| GZS-180-QCR                           | 18"       | 77.90  |
| GZS-240-QCR                           | 24"       | 86.40  |
| GZS-300-QCR                           | 30"       | 97.75  |
| GZS-320-QCR                           | 32"       | 102.25 |
| GZS-360-QCR                           | 36"       | 108.00 |
| GZS-420-QCR                           | 42"       | 118.00 |
| GZS-480-QCR                           | 48"       | 125.90 |
| "T" TUB & SHOWER                      |           |        |
| GZT-160160-QCR                        | 16" x 16" | 179.95 |
| GZT-160320-QCR                        | 16" x 32" | 205.90 |
| GZT-240240-QCR                        | 24" x 24" | 205.90 |
| GZT-200400-QCR                        | 20" x 40" | 238.70 |
| GZT-240360-QCR                        | 24" x 36" | 238.70 |
| GZT-240480-QCR                        | 24" x 48" | 269.90 |
| GZT-300300-QCR                        | 30" x 30" | 238.70 |
| GZT-360360-QCR                        | 36" x 36" | 269.90 |
| GZT-360480-QCR                        | 36" x 48" | 302.75 |
| GZT-360540-QCR                        | 36" x 54" | 318.70 |
| "V" VERTICAL ANGLE *(SPECIFY L or R)  |           |        |
| GZV*-160160-QCR                       | 16" x 16" | 179.95 |
| GZV*-200200-QCR                       | 20" x 20" | 192.90 |
| GZV*-240240-QCR                       | 24" x 24" | 205.90 |
| GZV*-300300-QCR                       | 30" x 30" | 238.70 |
| GZV*-160320-QCR                       | 16" x 32" | 205.90 |



**SIGNATURE SERIES GRAB BARS - DECORATIVE FINISHES STAINLESS - DOMESTIC GRAB BARS**  
**MADE IN THE U.S.A**

**"H" 1-1/2" TUBE DIAMETER**



| POLISHED STAINLESS "GX" SERIES       |           |        |
|--------------------------------------|-----------|--------|
| "H" 1-1/2" TUBE DIAMETER             |           |        |
| "S" STRAIGHT                         |           |        |
| ITEM#                                | SIZE      | LIST   |
| GXS-120-HCR                          | 12"       | 81.55  |
| GXS-160-HCR                          | 16"       | 90.50  |
| GXS-180-HCR                          | 18"       | 96.60  |
| GXS-240-HCR                          | 24"       | 116.80 |
| GXS-300-HCR                          | 30"       | 132.55 |
| GXS-320-HCR                          | 32"       | 140.95 |
| GXS-360-HCR                          | 36"       | 153.05 |
| GXS-420-HCR                          | 42"       | 169.15 |
| GXS-480-HCR                          | 48"       | 187.65 |
| "T" TUB & SHOWER                     |           |        |
| GXT-160160-HCR                       | 16" x 16" | 226.65 |
| GXT-160320-HCR                       | 16" x 32" | 268.00 |
| GXT-240240-HCR                       | 24" x 24" | 268.00 |
| GXT-200400-HCR                       | 20" x 40" | 303.25 |
| GXT-240360-HCR                       | 24" x 36" | 303.25 |
| GXT-240480-HCR                       | 24" x 48" | 339.65 |
| GXT-300300-HCR                       | 30" x 30" | 303.25 |
| GXT-360360-HCR                       | 36" x 36" | 339.70 |
| GXT-360480-HCR                       | 36" x 48" | 374.25 |
| GXT-360540-HCR                       | 36" x 54" | 391.45 |
| "V" VERTICAL ANGLE *(SPECIFY L or R) |           |        |
| GXV*-160160-HCR                      | 16" x 16" | 226.65 |
| GXV*-200200-HCR                      | 20" x 20" | 243.00 |
| GXV*-240240-HCR                      | 24" x 24" | 268.00 |
| GXV*-300300-HCR                      | 30" x 30" | 303.25 |
| GXV*-160320-HCR                      | 16" x 32" | 268.05 |

| PEENED WITH SATIN ENDS "GY" SERIES   |           |        |
|--------------------------------------|-----------|--------|
| "H" 1-1/2" TUBE DIAMETER             |           |        |
| "S" STRAIGHT                         |           |        |
| ITEM#                                | SIZE      | LIST   |
| GYS-120-HCR                          | 12"       | 62.85  |
| GYS-160-HCR                          | 16"       | 67.55  |
| GYS-180-HCR                          | 18"       | 71.60  |
| GYS-240-HCR                          | 24"       | 84.15  |
| GYS-300-HCR                          | 30"       | 93.10  |
| GYS-320-HCR                          | 32"       | 98.95  |
| GYS-360-HCR                          | 36"       | 106.20 |
| GYS-420-HCR                          | 42"       | 115.35 |
| GYS-480-HCR                          | 48"       | 126.60 |
| "T" TUB & SHOWER                     |           |        |
| GYT-160160-HCR                       | 16" x 16" | 189.80 |
| GYT-160320-HCR                       | 16" x 32" | 207.70 |
| GYT-240240-HCR                       | 24" x 24" | 207.70 |
| GYT-200400-HCR                       | 20" x 40" | 240.20 |
| GYT-240360-HCR                       | 24" x 36" | 240.20 |
| GYT-240480-HCR                       | 24" x 48" | 265.20 |
| GYT-300300-HCR                       | 30" x 30" | 240.20 |
| GYT-360360-HCR                       | 36" x 36" | 265.20 |
| GYT-360480-HCR                       | 36" x 48" | 288.60 |
| GYT-360540-HCR                       | 36" x 54" | 300.40 |
| "V" VERTICAL ANGLE *(SPECIFY L or R) |           |        |
| GYV*-160160-HCR                      | 16" x 16" | 189.80 |
| GYV*-200200-HCR                      | 20" x 20" | 198.90 |
| GYV*-240240-HCR                      | 24" x 24" | 207.70 |
| GYV*-300300-HCR                      | 30" x 30" | 240.20 |
| GYV*-160320-HCR                      | 16" x 32" | 207.70 |

| PEENED WITH POLISHED ENDS "GZ" SERIES |           |        |
|---------------------------------------|-----------|--------|
| "H" 1-1/2" TUBE DIAMETER              |           |        |
| "S" STRAIGHT                          |           |        |
| ITEM#                                 | SIZE      | LIST   |
| GZS-120-HCR                           | 12"       | 70.65  |
| GZS-160-HCR                           | 16"       | 75.90  |
| GZS-180-HCR                           | 18"       | 80.75  |
| GZS-240-HCR                           | 24"       | 92.45  |
| GZS-300-HCR                           | 30"       | 102.25 |
| GZS-320-HCR                           | 32"       | 107.00 |
| GZS-360-HCR                           | 36"       | 116.05 |
| GZS-420-HCR                           | 42"       | 122.55 |
| GZS-480-HCR                           | 48"       | 132.85 |
| "T" TUB & SHOWER                      |           |        |
| GZT-160160-HCR                        | 16" x 16" | 204.70 |
| GZT-160320-HCR                        | 16" x 32" | 230.30 |
| GZT-240240-HCR                        | 24" x 24" | 230.30 |
| GZT-200400-HCR                        | 20" x 40" | 268.60 |
| GZT-240360-HCR                        | 24" x 36" | 268.60 |
| GZT-240480-HCR                        | 24" x 48" | 299.20 |
| GZT-300300-HCR                        | 30" x 30" | 268.60 |
| GZT-360360-HCR                        | 36" x 36" | 299.20 |
| GZT-360480-HCR                        | 36" x 48" | 328.00 |
| GZT-360540-HCR                        | 36" x 54" | 342.60 |
| "V" VERTICAL ANGLE *(SPECIFY L or R)  |           |        |
| GZV*-160160-HCR                       | 16" x 16" | 204.70 |
| GZV*-200200-HCR                       | 20" x 20" | 217.90 |
| GZV*-240240-HCR                       | 24" x 24" | 230.30 |
| GZV*-300300-HCR                       | 30" x 30" | 268.60 |
| GZV*-160320-HCR                       | 16" x 32" | 230.30 |

**SIGNATURE SERIES GRAB BARS - POLISHED BRASS - POWDER COAT - DOMESTIC GRAB BARS**  
**MADE IN THE U.S.A**

**POWDER COAT (PC) OPTIONS:**

PLEASE CALL FOR CUSTOM COLOR OPTIONS



AL - ALMOND



AW - ALMOND WRINKLE



BI - BISCUIT



BK - BLACK



BR - BRONZE



DB - DARK BRONZE



MB - MATTE BLACK



MWT - MATTE WHITE



PS - POLISHED



PB - POLISHED BRASS



SB - SATIN BRASS



SN - SATIN NICKEL

EXAMPLE: GPS-120-QCR-SN



SS - SATIN



WT - WHITE



WW - WHITE WRINKLE

| POLISHED BRASS "GB SERIES"           |           |        |
|--------------------------------------|-----------|--------|
| "Q" 1-1/4" TUBE DIAMETER             |           |        |
| "S" STRAIGHT                         |           |        |
| ITEM#                                | SIZE      | LIST   |
| GBS-120-QCB-BB                       | 12"       | 102.45 |
| GBS-160-QCB-BB                       | 16"       | 107.40 |
| GBS-180-QCB-BB                       | 18"       | 110.50 |
| GBS-240-QCB-BB                       | 24"       | 126.45 |
| GBS-300-QCB-BB                       | 30"       | 141.40 |
| GBS-320-QCB-BB                       | 32"       | 144.90 |
| GBS-360-QCB-BB                       | 36"       | 159.15 |
| GBS-420-QCB-BB                       | 42"       | 181.15 |
| GBS-480-QCB-BB                       | 48"       | 220.00 |
| "T" TUB & SHOWER                     |           |        |
| GBT-160160-QCB-BB                    | 16" x 16" | 232.15 |
| GBT-160320-QCB-BB                    | 16" x 32" | 300.85 |
| GBT-240240-QCB-BB                    | 24" x 24" | 300.85 |
| GBT-200400-QCB-BB                    | 20" x 40" | 386.90 |
| GBT-240360-QCB-BB                    | 24" x 36" | 386.90 |
| GBT-240480-QCB-BB                    | 24" x 48" | 464.15 |
| GBT-300300-QCB-BB                    | 30" x 30" | 386.90 |
| GBT-360360-QCB-BB                    | 36" x 36" | 464.15 |
| GBT-360480-QCB-BB                    | 36" x 48" | 541.70 |
| GBT-360540-QCB-BB                    | 36" x 54" | 575.90 |
| "V" VERTICAL ANGLE *(SPECIFY L or R) |           |        |
| GBV*-160160-QCB-BB                   | 16" x 16" | 232.15 |
| GBV*-200200-QCB-BB                   | 20" x 20" | 266.50 |
| GBV*-240240-QCB-BB                   | 24" x 24" | 300.85 |
| GBV*-300300-QCB-BB                   | 30" x 30" | 386.90 |
| GBV*-160320-QCB-BB                   | 16" x 32" | 300.85 |

| POWDER COATED STAINLESS "GP SERIES"  |           |        |
|--------------------------------------|-----------|--------|
| "Q" 1-1/4" TUBE DIAMETER             |           |        |
| "S" STRAIGHT                         |           |        |
| ITEM#                                | SIZE      | LIST   |
| GPS-120-QCR                          | 12"       | 73.65  |
| GPS-160-QCR                          | 16"       | 79.30  |
| GPS-180-QCR                          | 18"       | 82.95  |
| GPS-240-QCR                          | 24"       | 94.10  |
| GPS-300-QCR                          | 30"       | 105.15 |
| GPS-320-QCR                          | 32"       | 108.85 |
| GPS-360-QCR                          | 36"       | 114.25 |
| GPS-420-QCR                          | 42"       | 123.60 |
| GPS-480-QCR                          | 48"       | 134.50 |
| "T" TUB & SHOWER                     |           |        |
| GPT-160160-QCR                       | 16" x 16" | 164.45 |
| GPT-160320-QCR                       | 16" x 32" | 188.80 |
| GPT-240240-QCR                       | 24" x 24" | 188.80 |
| GPT-200400-QCR                       | 20" x 40" | 219.70 |
| GPT-240360-QCR                       | 24" x 36" | 219.70 |
| GPT-240480-QCR                       | 24" x 48" | 249.05 |
| GPT-300300-QCR                       | 30" x 30" | 219.70 |
| GPT-360360-QCR                       | 36" x 36" | 249.05 |
| GPT-360480-QCR                       | 36" x 48" | 279.55 |
| GPT-360540-QCR                       | 36" x 54" | 294.00 |
| "V" VERTICAL ANGLE *(SPECIFY L or R) |           |        |
| GPV*-160160-QCR                      | 16" x 16" | 164.45 |
| GPV*-200200-QCR                      | 20" x 20" | 176.55 |
| GPV*-240240-QCR                      | 24" x 24" | 188.80 |
| GPV*-300300-QCR                      | 30" x 30" | 219.70 |
| GPV*-160320-QCR                      | 16" x 32" | 188.80 |

| POWDER COATED STAINLESS "GP SERIES"  |           |        |
|--------------------------------------|-----------|--------|
| "H" 1-1/2" TUBE DIAMETER             |           |        |
| "S" STRAIGHT                         |           |        |
| ITEM#                                | SIZE      | LIST   |
| GPS-120-HCR                          | 12"       | 82.70  |
| GPS-160-HCR                          | 16"       | 90.15  |
| GPS-180-HCR                          | 18"       | 93.90  |
| GPS-240-HCR                          | 24"       | 118.30 |
| GPS-300-HCR                          | 30"       | 123.25 |
| GPS-320-HCR                          | 32"       | 125.95 |
| GPS-360-HCR                          | 36"       | 131.50 |
| GPS-420-HCR                          | 42"       | 140.95 |
| GPS-480-HCR                          | 48"       | 152.05 |
| "T" TUB & SHOWER                     |           |        |
| GPT-160160-HCR                       | 16" x 16" | 186.00 |
| GPT-160320-HCR                       | 16" x 32" | 209.85 |
| GPT-240240-HCR                       | 24" x 24" | 209.85 |
| GPT-200400-HCR                       | 20" x 40" | 245.65 |
| GPT-240360-HCR                       | 24" x 36" | 245.65 |
| GPT-240480-HCR                       | 24" x 48" | 274.90 |
| GPT-300300-HCR                       | 30" x 30" | 245.65 |
| GPT-360360-HCR                       | 36" x 36" | 274.90 |
| GPT-360480-HCR                       | 36" x 48" | 301.45 |
| GPT-360540-HCR                       | 36" x 54" | 314.95 |
| "V" VERTICAL ANGLE *(SPECIFY L or R) |           |        |
| GPV*-160160-HCR                      | 16" x 16" | 186.00 |
| GPV*-200200-HCR                      | 20" x 20" | 193.30 |
| GPV*-240240-HCR                      | 24" x 24" | 209.85 |
| GPV*-300300-HCR                      | 30" x 30" | 245.65 |
| GPV*-160320-HCR                      | 16" x 32" | 209.85 |

**SIGNATURE SERIES GRAB BARS**

MADE IN THE U.S.A

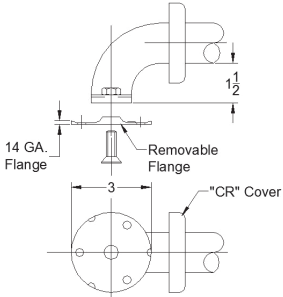
|   |   |
|---|---|
|  | <b>SIGNATURE SERIES - CUSTOM GRAB BARS</b>  |
|   | <p>Seachrome can manufacture your custom size grab bar in any number of configurations, sizes, and finishes. Please contact Seachrome and speak with your Account Manager for information on pricing and lead times. All custom grab bars are manufactured to meet Federal Specifications and ADA Requirements.</p> |



- When properly mounted, the bariatric grab bar system supports up to 1,250 lbs.
- Heavy-Duty #304 Stainless Steel
- Bariatric Grab Bars meet Federal Specification WW-P-541/8b
- Fully ADA Compliant when installed properly

| BARIATRIC GRAB BARS - RATED TO 1,250 LBS |        |                     |        |        |          |          |        |
|--|--------|---------------------|--------|--------|----------|----------|--------|
| ITEM#                                    | LENGTH | SUPPORT LOCATION(S) | SATIN  |        | ITEM#    | POLISHED |        |
|  |        |                     | QCR    | HCR    |          | QCR      | HCR    |
| GSBB-240                                 | 24"    | 1 at 12"            | 90.60  | 95.05  | GXBB-240 | 117.80   | 123.60 |
| GSBB-360                                 | 36"    | 1 at 18"            | 97.70  | 102.60 | GXBB-360 | 127.10   | 133.45 |
| GSBB-420                                 | 42"    | 1 at 21"            | 113.90 | 119.60 | GXBB-420 | 148.10   | 155.55 |
| GSBB-480                                 | 48"    | 1 at 16" - 1 at 32" | 148.35 | 155.80 | GXBB-480 | 192.90   | 202.60 |
| GSBB-520                                 | 52"    | 1 at 17" - 1 at 35" | 153.60 | 161.25 | GXBB-520 | 199.65   | 209.65 |
| GSBB-540                                 | 54"    | 1 at 18" - 1 at 36" | 156.80 | 164.70 | GXBB-540 | 203.85   | 214.00 |
| GSBB-600                                 | 60"    | 1 at 20" - 1 at 40" | 161.90 | 169.95 | GXBB-600 | 210.45   | 220.95 |



**HEW Configuration**



**HEO Configuration**



**QWB Configuration**

| LIGATURE RESISTANT GRAB BARS |        |                 |        |           |             |        |                                |
|------------------------------|--------|-----------------|--------|-----------|-------------|--------|--------------------------------|
| ITEM#                        | LENGTH | CONTINUOUS WELD |        | ITEM#     | STITCH WELD |        | STITCH WELD FLANGELESS BRACKET |
|                              |        | HEW             | HEO    |           | HEW         | HEO    | QWB                            |
| GSSI-160                     | 16"    | 142.65          | 140.60 | GSSIS-160 | 129.80      | 127.75 | 168.25                         |
| GSSI-180                     | 18"    | 151.60          | 149.55 | GSSIS-180 | 136.30      | 134.20 | 178.95                         |
| GSSI-240                     | 24"    | 182.95          | 180.90 | GSSIS-240 | 157.35      | 155.25 | 215.90                         |
| GSSI-300                     | 30"    | 210.10          | 208.10 | GSSIS-300 | 174.25      | 172.25 | 247.95                         |
| GSSI-320                     | 32"    | 218.10          | 216.05 | GSSIS-320 | 183.35      | 181.30 | 257.30                         |
| GSSI-360                     | 36"    | 239.20          | 239.35 | GSSIS-360 | 190.20      | 188.20 | 282.30                         |
| GSSI-420                     | 42"    | 268.65          | 266.55 | GSSIS-420 | 217.40      | 215.35 | 317.00                         |
| GSSI-480                     | 48"    | 304.10          | 302.05 | GSSIS-480 | 252.85      | 250.85 | 358.85                         |

**LIFESTYLE & WELLNESS® SERIES GRAB BARS**

MADE IN THE U.S.A

| POWDER COAT OPTIONS |                  |     |                |
|---------------------|------------------|-----|----------------|
| AL                  | ALMOND           | MB  | MATTE BLACK    |
| AW                  | ALMOND WRINKLE   | MWT | MATTE WHITE    |
| BI                  | BISCUIT          | PB  | POLISHED BRASS |
| BK                  | BLACK            | SB  | SATIN BRASS    |
| BSG                 | BLACK SEMI-GLOSS | SN  | SATIN NICKEL   |
| BW                  | BLACK WRINKLE    | WT  | WHITE          |
| BR                  | BRONZE           | WW  | WHITE WRINKLE  |
| DB                  | DARK BRONZE      |     |                |

| FINISH OPTIONS |                          |
|----------------|--------------------------|
| PS             | POLISHED STAINLESS STEEL |
| SS             | SATIN STAINLESS STEEL    |
| PC             | POWDER COAT FINISH       |

QCR= 1-1/4" O.D. BAR / CONCEALED FLANGE

Lifestyle & Wellness® Grab Bars meet Federal Specification WW-P-541/8b and exceed the minimum ADA requirement of 250-pounds of pull force when properly installed.



GW-3016-SERIES



GW-3518-SERIES  
GW-3524-SERIES  
GW-3536-SERIES  
GW-3548-SERIES



GWL-3638-SERIES

| ITEM#    | DESCRIPTION                     | SS - QCR | PS - QCR | PC - QCR |
|----------|---------------------------------|----------|----------|----------|
| GW-3016  | WEDGE BAR 16" x 16"             | 149.25   | 183.00   | 183.00   |
| GW-3518  | WAVE BAR 18" OVERALL            | 131.55   | 177.50   | 177.50   |
| GW-3524  | WAVE BAR 24" OVERALL            | 135.65   | 183.00   | 183.00   |
| GW-3536  | WAVE BAR 36" OVERALL            | 145.20   | 192.80   | 192.80   |
| GW-3548  | WAVE BAR 48" OVERALL            | 156.00   | 198.00   | 198.00   |
| GWL-3638 | LH ZUMA BAR 16" x 11-3/4" x 16" | 169.60   | 215.25   | 215.25   |
| GWR-3638 | RH ZUMA BAR 16" x 11-3/4" x 16" | 169.60   | 215.25   | 215.25   |



GW-3130-SERIES



GW-3430-SERIES

| ITEM#   | DESCRIPTION                                 | SS - QCR | PS - QCR | PC - QCR |
|---------|---|----------|----------|----------|
| GW-3130 | MAVERICK DOUBLE ARCHED GRAB BAR 30" OVERALL | 169.60   | 215.05   | 215.05   |
| GW-3430 | CRESCENT GRAB BAR 30"                       | 169.60   | 215.05   | 215.05   |



GW-3230-SERIES



GW-3924 SERIES  
GW-3930-SERIES



| ITEM#   | DESCRIPTION                                      | SS - QCR | PS - QCR | PC - QCR |
|---------|--|----------|----------|----------|
| GW-3230 | HALF-MOON BAY CURVED GRAB BAR WITH TOWEL BAR 30" | 183.10   | 231.85   | 231.85   |
| GW-3924 | NEWPORT GRAB BAR WITH TOWEL BAR 24" OVERALL      | 141.80   | 175.30   | 175.30   |
| GW-3930 | NEWPORT GRAB BAR WITH TOWEL BAR 30" OVERALL      | 149.25   | 184.45   | 184.45   |

**LIFESTYLE & WELLNESS® SERIES GRAB BARS**

MADE IN THE U.S.A

| POWDER COAT OPTIONS |                  |     |                |
|---------------------|------------------|-----|----------------|
| AL                  | ALMOND           | MB  | MATTE BLACK    |
| AW                  | ALMOND WRINKLE   | MWT | MATTE WHITE    |
| BI                  | BISCUIT          | PB  | POLISHED BRASS |
| BK                  | BLACK            | SB  | SATIN BRASS    |
| BSG                 | BLACK SEMI-GLOSS | SN  | SATIN NICKEL   |
| BW                  | BLACK WRINKLE    | WT  | WHITE          |
| BR                  | BRONZE           | WW  | WHITE WRINKLE  |
| DB                  | DARK BRONZE      |     |                |

| FINISH OPTIONS |                          |
|----------------|--------------------------|
| PS             | POLISHED STAINLESS STEEL |
| SS             | SATIN STAINLESS STEEL    |
| PC             | POWDER COAT FINISH       |

QCR= 1-1/4" O.D. BAR / CONCEALED FLANGE



GWR-3330-SERIES



GWR-3730-SERIES

| ITEM#    | DESCRIPTION   | SS - QCR | PS - QCR | PC - QCR |
|----------|---|----------|----------|----------|
| GWL-3330 | LH PISMO CURVED GRAB BAR WITH TOILET PAPER HOLDER 30" | 189.85   | 233.30   | 233.30   |
| GWR-3330 | RH PISMO CURVED GRAB BAR WITH TOILET PAPER HOLDER 30" | 189.85   | 233.30   | 233.30   |
| GWL-3730 | LH PIANO CURVED GRAB BAR WITH TOWEL BAR 30"           | 203.50   | 247.30   | 247.30   |
| GWR-3730 | RH PIANO CURVED GRAB BAR WITH TOWEL BAR 30"           | 203.50   | 247.30   | 247.30   |



GW-4130-Q-SERIES

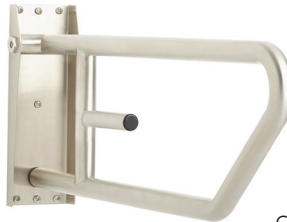

GW1-4130-Q-SERIES



GW-4612-SERIES

| ITEM#    | DESCRIPTION   | SS - QCR | PS - QCR | PC - QCR |
|----------|---|----------|----------|----------|
| GW-4130  | SWING-UP GRAB BAR 30" OVERALL                           | 417.70   | 593.90   | 593.90   |
| GW1-4130 | SWING-UP GRAB BAR 30" OVERALL WITH TOILET PAPER HOLDER  | 436.70   | 620.90   | 620.90   |
| GW-4612  | MANHATTAN GRAB BAR 12" OVERALL WITH TOILET PAPER HOLDER | 155.00   | 173.10   | 173.10   |



GW-4412-QNT-SERIES



GW-4236-Q-SERIES



GW-4339-Q-SERIES

| ITEM#       | DESCRIPTION                                      | SS - QCR | PS - QCR | PC - QCR |
|-------------|--|----------|----------|----------|
| GW-4412-QNT | HUNTINGTON SHOWER VALVE GRAB BAR 12" FRONT MOUNT | 156.00   | 185.85   | 195.70   |
| GW-4236-Q   | WALL-TO-WALL SWING-AWAY 36" GRAB BAR             | 493.75   | 681.70   | -        |
| GW-4339-Q   | WALL-TO-FLOOR SWING-AWAY 39" GRAB BAR            | 535.75   | 733.45   | -        |

THE ABOVE MODELS REPRESENT OUR STANDARD LIFESTYLE & WELLNESS® SERIES. SEACHROME DESIGNS, ENGINEERS AND MANUFACTURES CUSTOM SIZES AND STYLES. CUSTOM FINISHES ARE ALSO AVAILABLE. PLEASE CALL FOR A QUOTATION.

**CORONADO SERIES - GRAB BARS**

MADE IN THE U.S.A

| POWDER COAT OPTIONS |                  |     |                |
|---------------------|------------------|-----|----------------|
| AL                  | ALMOND           | MB  | MATTE BLACK    |
| AW                  | ALMOND WRINKLE   | MWT | MATTE WHITE    |
| BI                  | BISCUIT          | PB  | POLISHED BRASS |
| BK                  | BLACK            | SB  | SATIN BRASS    |
| BSG                 | BLACK SEMI-GLOSS | SN  | SATIN NICKEL   |
| BW                  | BLACK WRINKLE    | WT  | WHITE          |
| BR                  | BRONZE           | WW  | WHITE WRINKLE  |
| DB                  | DARK BRONZE      |     |                |

| GRAB BAR FEATURES                        |
|--|
| • #304 STAINLESS STEEL                   |
| • WELDED CONSTRUCTION                    |
| • CUSTOM FINISHES AND COLORS AVAILABLE   |
| • 3" ROUND CONCEALED FLANGES             |
| • AVAILABLE IN DECORATIVE FLANGE DESIGNS |

| FINISH OPTIONS |                    |
|----------------|--------------------|
| PS             | POLISHED FINISH    |
| SS             | SATIN FINISH       |
| PC             | POWDER COAT FINISH |

All Coronado Series Grab Bars meet Federal Specification WW-P-541/8b for welded construction and withstanding 250 lbs. of force when properly installed.

QCR= 1-1/4" O.D. BAR / CONCEALED FLANGES  
HCR= 1-1/2" O.D. BAR / CONCEALED FLANGES



790-240-QCR-SS



| 790 SERIES - CORONADO |  |        |        |        |
|-----------------------|--|--------|--------|--------|
| ITEM#                 | DESCRIPTION                                  | SS     | PS     | PC     |
| 790-120-QCR           | 12" GRAB BAR, 1-1/4" O.D., CONCEALED FLANGES | 122.35 | 144.60 | 144.60 |
| 790-180-QCR           | 18" GRAB BAR, 1-1/4" O.D., CONCEALED FLANGES | 128.55 | 156.40 | 156.40 |
| 790-240-QCR           | 24" GRAB BAR, 1-1/4" O.D., CONCEALED FLANGES | 146.00 | 183.40 | 183.40 |
| 790-360-QCR           | 36" GRAB BAR, 1-1/4" O.D., CONCEALED FLANGES | 162.10 | 216.55 | 216.55 |
| 790-420-QCR           | 42" GRAB BAR, 1-1/4" O.D., CONCEALED FLANGES | 188.30 | 254.20 | 254.20 |
| 790-480-QCR           | 48" GRAB BAR, 1-1/4" O.D., CONCEALED FLANGES | 201.85 | 279.50 | 279.50 |
| 790-120-HCR           | 12" GRAB BAR, 1-1/2" O.D., CONCEALED FLANGES | 128.55 | 151.85 | 151.85 |
| 790-180-HCR           | 18" GRAB BAR, 1-1/2" O.D., CONCEALED FLANGES | 139.65 | 172.95 | 172.95 |
| 790-240-HCR           | 24" GRAB BAR, 1-1/2" O.D., CONCEALED FLANGES | 166.45 | 204.85 | 204.85 |
| 790-360-HCR           | 36" GRAB BAR, 1-1/2" O.D., CONCEALED FLANGES | 184.00 | 240.55 | 240.55 |
| 790-420-HCR           | 42" GRAB BAR, 1-1/2" O.D., CONCEALED FLANGES | 216.05 | 282.60 | 282.60 |
| 790-480-HCR           | 48" GRAB BAR, 1-1/2" O.D., CONCEALED FLANGES | 255.05 | 307.50 | 307.50 |



791-240-QCR-SS



| 791 SERIES - CORONADO |  |        |        |        |
|-----------------------|--|--------|--------|--------|
| ITEM#                 | DESCRIPTION  | SS     | PS     | PC     |
| 791-120-QCR           | 12" GRAB BAR, 1-1/4" O.D., CONCEALED FLANGES, 1-1/2" POSTS | 141.30 | 169.60 | 169.60 |
| 791-180-QCR           | 18" GRAB BAR, 1-1/4" O.D., CONCEALED FLANGES, 1-1/2" POSTS | 160.60 | 195.45 | 195.45 |
| 791-240-QCR           | 24" GRAB BAR, 1-1/4" O.D., CONCEALED FLANGES, 1-1/2" POSTS | 182.55 | 216.00 | 216.00 |
| 791-360-QCR           | 36" GRAB BAR, 1-1/4" O.D., CONCEALED FLANGES, 1-1/2" POSTS | 201.45 | 270.70 | 270.70 |
| 791-420-QCR           | 42" GRAB BAR, 1-1/4" O.D., CONCEALED FLANGES, 1-1/2" POSTS | 233.55 | 315.75 | 315.75 |
| 791-480-QCR           | 48" GRAB BAR, 1-1/4" O.D., CONCEALED FLANGES, 1-1/2" POSTS | 268.60 | 342.30 | 342.30 |

NOTE: 791 SERIES GRAB BARS AVAILABLE IN 1-1/4" O.D. ONLY



793-240-QCR-PS



| 793 SERIES - CORONADO |  |        |        |        |
|-----------------------|--|--------|--------|--------|
| ITEM#                 | DESCRIPTION  | SS     | PS     | PC     |
| 793-120-QCR           | 12" GRAB BAR, 1-1/4" O.D., CONCEALED FLANGES, 1-1/4" POSTS | 131.85 | 156.95 | 156.95 |
| 793-180-QCR           | 18" GRAB BAR, 1-1/4" O.D., CONCEALED FLANGES, 1-1/4" POSTS | 149.90 | 191.55 | 191.55 |
| 793-240-QCR           | 24" GRAB BAR, 1-1/4" O.D., CONCEALED FLANGES, 1-1/4" POSTS | 170.40 | 211.70 | 211.70 |
| 793-360-QCR           | 36" GRAB BAR, 1-1/4" O.D., CONCEALED FLANGES, 1-1/4" POSTS | 188.10 | 265.25 | 265.25 |
| 793-420-QCR           | 42" GRAB BAR, 1-1/4" O.D., CONCEALED FLANGES, 1-1/4" POSTS | 217.95 | 309.45 | 309.45 |
| 793-480-QCR           | 48" GRAB BAR, 1-1/4" O.D., CONCEALED FLANGES, 1-1/4" POSTS | 252.80 | 329.35 | 329.35 |

NOTE: 793 SERIES GRAB BARS AVAILABLE IN 1-1/4" O.D. ONLY

**CORONADO SERIES - GRAB BARS**

MADE IN THE U.S.A

| POWDER COAT OPTIONS |                  |     |                |
|---------------------|------------------|-----|----------------|
| AL                  | ALMOND           | MB  | MATTE BLACK    |
| AW                  | ALMOND WRINKLE   | MWT | MATTE WHITE    |
| BI                  | BISCUIT          | PB  | POLISHED BRASS |
| BK                  | BLACK            | SB  | SATIN BRASS    |
| BSG                 | BLACK SEMI-GLOSS | SN  | SATIN NICKEL   |
| BW                  | BLACK WRINKLE    | WT  | WHITE          |
| BR                  | BRONZE           | WW  | WHITE WRINKLE  |
| DB                  | DARK BRONZE      |     |                |

| GRAB BAR FEATURES                        |
|--|
| • #304 STAINLESS STEEL                   |
| • WELDED CONSTRUCTION                    |
| • CUSTOM FINISHES AND COLORS AVAILABLE   |
| • 3" ROUND CONCEALED FLANGES             |
| • AVAILABLE IN DECORATIVE FLANGE DESIGNS |

| FINISH OPTIONS |                    |
|----------------|--------------------|
| PS             | POLISHED FINISH    |
| SS             | SATIN FINISH       |
| PC             | POWDER COAT FINISH |

All Coronado Series Grab Bars meet Federal Specification WW-P-541/8b for welded construction and withstanding 250 lbs. of force when properly installed.

QCR= 1-1/4" O.D. BAR / CONCEALED FLANGES  
 HCR= 1-1/2" O.D. BAR / CONCEALED FLANGES



GSO-240-HCR-PS



| OVAL SERIES |   |        |        |        |
|-------------|---|--------|--------|--------|
| ITEM#       | DESCRIPTION   | SS     | PS     | PC     |
| GSO-120-HCR | 12" OVAL GRAB BAR - MITERED CORNERS, 1-1/2" O.D., CONCEALED FLANGES | 162.45 | 191.80 | 191.80 |
| GSO-180-HCR | 18" OVAL GRAB BAR - MITERED CORNERS, 1-1/2" O.D., CONCEALED FLANGES | 184.65 | 217.35 | 217.35 |
| GSO-240-HCR | 24" OVAL GRAB BAR - MITERED CORNERS, 1-1/2" O.D., CONCEALED FLANGES | 202.10 | 244.30 | 244.30 |
| GSO-360-HCR | 36" OVAL GRAB BAR - MITERED CORNERS, 1-1/2" O.D., CONCEALED FLANGES | 218.30 | 277.35 | 277.35 |
| GSO-420-HCR | 42" OVAL GRAB BAR - MITERED CORNERS, 1-1/2" O.D., CONCEALED FLANGES | 244.50 | 315.75 | 315.75 |
| GSO-480-HCR | 48" OVAL GRAB BAR - MITERED CORNERS, 1-1/2" O.D., CONCEALED FLANGES | 284.80 | 347.10 | 347.10 |

NOTE: OVAL SERIES GRAB BARS AVAILABLE IN 1-1/2" O.D. ONLY



GSSO-240-QCR-SS



| OVAL SERIES  |  |        |        |        |
|--------------|--|--------|--------|--------|
| ITEM#        | DESCRIPTION  | SS     | PS     | PC     |
| GSSO-120-HCR | 12" OVAL GRAB BAR - CORONADO STYLE, 1-1/2" O.D., CONCEALED FLANGES | 149.70 | 169.85 | 169.85 |
| GSSO-180-HCR | 18" OVAL GRAB BAR - CORONADO STYLE, 1-1/2" O.D., CONCEALED FLANGES | 170.10 | 202.30 | 202.30 |
| GSSO-240-HCR | 24" OVAL GRAB BAR - CORONADO STYLE, 1-1/2" O.D., CONCEALED FLANGES | 187.55 | 229.35 | 229.35 |
| GSSO-360-HCR | 36" OVAL GRAB BAR - CORONADO STYLE, 1-1/2" O.D., CONCEALED FLANGES | 203.65 | 262.40 | 262.40 |
| GSSO-420-HCR | 42" OVAL GRAB BAR - CORONADO STYLE, 1-1/2" O.D., CONCEALED FLANGES | 229.95 | 290.65 | 290.65 |
| GSSO-480-HCR | 48" OVAL GRAB BAR - CORONADO STYLE, 1-1/2" O.D., CONCEALED FLANGES | 255.10 | 300.00 | 300.00 |

NOTE: OVAL SERIES GRAB BARS AVAILABLE IN 1-1/2" O.D. ONLY



GXS2-240-QSS-PS



| SQUARE FLANGE GRAB BAR - SQUARE STEP FLANGE COVER |  |        |        |        |
|---|--|--------|--------|--------|
| ITEM#   | DESCRIPTION  | SS     | PS     | PC     |
| GXS2-120-QSS                                      | 12" GRAB BAR, 1-1/4" O.D., SQUARE STAINLESS STEP FLANGES | 170.15 | 191.55 | 191.55 |
| GXS2-180-QSS                                      | 18" GRAB BAR, 1-1/4" O.D., SQUARE STAINLESS STEP FLANGES | 193.45 | 221.00 | 221.00 |
| GXS2-240-QSS                                      | 24" GRAB BAR, 1-1/4" O.D., SQUARE STAINLESS STEP FLANGES | 211.80 | 248.50 | 248.50 |
| GXS2-360-QSS                                      | 36" GRAB BAR, 1-1/4" O.D., SQUARE STAINLESS STEP FLANGES | 228.70 | 282.15 | 282.15 |
| GXS2-420-QSS                                      | 42" GRAB BAR, 1-1/4" O.D., SQUARE STAINLESS STEP FLANGES | 256.20 | 320.35 | 320.35 |
| GXS2-480-QSS                                      | 48" GRAB BAR, 1-1/4" O.D., SQUARE STAINLESS STEP FLANGES | 297.20 | 351.70 | 351.70 |

NOTE: SQUARE FLANGE GRAB BARS AVAILABLE IN 1-1/4" O.D. ONLY

**SIGNATURE SERIES - ADA ACCESSIBILITY SHOWER SEATS**

MADE IN THE U.S.A

| SEAT TOP MATERIAL OPTIONS |                    |                   |                   |                     |  |
|---------------------------|--------------------|-------------------|-------------------|---------------------|--|
| ONE-PIECE SOLID PHENOLIC  |                    | 3" PHENOLIC SLATS |                   | OTHER               |  |
| PAS ALMOND                | PRTS RUSTIC TEAK   | PA ALMOND         | PRT RUSTIC TEAK   | NA NAUGAHYDE ALMOND |  |
| PAAS AGED ASH             | PTS TEAK           | PAA AGED ASH      | PT TEAK           | NW NAUGAHYDE WHITE  |  |
| PBS BLACK                 | PWAS WEATHERED ASH | PB BLACK          | PWA WEATHERED ASH |                     |  |
| PGS GREY                  | PWS WHITE          | PG GREY           | PW WHITE          |                     |  |
| PLGS LIGHT GREY           |                    | PLG LIGHT GREY    |                   |                     |  |

All Seachrome seats meet Federal Specification WW-P-541/8b and all ADA code requirements (250 lbs. of force) when properly installed.

**REVERSIBLE TRANSFER SEAT FEATURES:**

Seachrome Reversible Transfer Seat Tops can be changed to accommodate Left or Right-Handed configuration

- One-Piece welded frame ensures durability
- Seat top is countersunk on both sides
- Available in a variety of seat top colors
- Seat top is packed separately for easy installation

For EXTRA HEAVY load requirements, select SSR2, SSL2, or SSB2 Models, which have been tested to withstand 1,000 lbs. of force when properly installed.



**Lift-Assist** All Seachrome seats are fabricated using Seachrome's patented Lift-Assist Technology (Patent # US 9,844,272 B1) and meet ADA Code Operation 309.4 which requires 5 lbs. of force or less to raise the seat.



SLR-280225-PWS  
Left-Handed Shown



SLR2-320225-PWS  
Right-Handed Shown



| REVERSIBLE TRANSFER SEATS |   |      |     |                          |  |
|---------------------------|---|------|-----|--------------------------|--|
| ITEM#                     | DESCRIPTION   | CUBE | LBS | ONE-PIECE SOLID PHENOLIC |  |
| SLR-260225                | LH/RH L-SHAPED SHOWER SEAT 26" x 22.5"                          | 3.31 | 24  | 488.25                   |  |
| SLR-280225                | LH/RH L-SHAPED SHOWER SEAT 28" x 22.5"                          | 3.31 | 24  | 501.50                   |  |
| SLR-320225                | LH/RH L-SHAPED SHOWER SEAT 32" x 22.5"                          | 3.31 | 25  | 516.60                   |  |
| SLR-345225                | LH/RH L-SHAPED SHOWER SEAT 34.5" x 22.5"                        | 3.31 | 27  | 557.20                   |  |
| SLR2-260225               | LH/RH L-SHAPED SHOWER SEAT (with swing-down legs) 26" x 22.5"   | 3.22 | 26  | 574.50                   |  |
| SLR2-280225               | LH/RH L-SHAPED SHOWER SEAT (with swing-down legs) 28" x 22.5"   | 3.22 | 27  | 588.05                   |  |
| SLR2-320225               | LH/RH L-SHAPED SHOWER SEAT (with swing-down legs) 32" x 22.5"   | 3.22 | 28  | 601.55                   |  |
| SLR2-345225               | LH/RH L-SHAPED SHOWER SEAT (with swing-down legs) 34.5" x 22.5" | 3.22 | 30  | 632.40                   |  |
| SLR2-360225               | LH/RH L-SHAPED SHOWER SEAT (with swing-down legs) 36" x 22.5"   | 3.22 | 30  | 660.60                   |  |
| SLR2-420225               | LH/RH L-SHAPED SHOWER SEAT (with swing-down legs) 42" x 22.5"   | 3.22 | 32  | 790.25                   |  |



SSB-180150-PWS



SSB-180150-NW



SSB2-280150-PWS



SSB2-240150-NW

| BENCH SEATS |  |      |     |          |                   |                          |  |
|-------------|--|------|-----|----------|-------------------|--------------------------|--|
| ITEM#       | DESCRIPTION  | CUBE | LBS | NA/NW    | 3" PHENOLIC SLATS | ONE-PIECE SOLID PHENOLIC |  |
| SSB-180150  | BENCH STYLE SHOWER SEAT 18" x 15"                        | 3.31 | 16  | 393.90   | 454.25            | 454.25                   |  |
| SSB-220150  | BENCH STYLE SHOWER SEAT 22" x 15"                        | 3.31 | 18  | 436.60   | 496.55            | 496.55                   |  |
| SSB-240150  | BENCH STYLE SHOWER SEAT 24" x 15"                        | 3.31 | 19  | 458.65   | 516.40            | 516.40                   |  |
| SSB-280150  | BENCH STYLE SHOWER SEAT 28" x 15"                        | 3.31 | 20  | 494.40   | 550.85            | 550.85                   |  |
| SSB-300150  | BENCH STYLE SHOWER SEAT 30" x 15"                        | 3.31 | 21  | 516.40   | 585.30            | 585.30                   |  |
| SSB-320150  | BENCH STYLE SHOWER SEAT 32" x 15"                        | 3.31 | 22  | 537.05   | 606.55            | 606.55                   |  |
| SSB2-180150 | BENCH STYLE SHOWER SEAT (with swing-down legs) 18" x 15" | 3.31 | 19  | 527.35   | 558.80            | 558.80                   |  |
| SSB2-220150 | BENCH STYLE SHOWER SEAT (with swing-down legs) 22" x 15" | 3.31 | 20  | 573.05   | 593.25            | 593.25                   |  |
| SSB2-240150 | BENCH STYLE SHOWER SEAT (with swing-down legs) 24" x 15" | 3.31 | 22  | 594.50   | 613.85            | 613.85                   |  |
| SSB2-280150 | BENCH STYLE SHOWER SEAT (with swing-down legs) 28" x 15" | 3.31 | 26  | 631.70   | 647.95            | 647.95                   |  |
| SSB2-300150 | BENCH STYLE SHOWER SEAT (with swing-down legs) 30" x 15" | 3.31 | 27  | 654.45   | 675.55            | 675.55                   |  |
| SSB2-320150 | BENCH STYLE SHOWER SEAT (with swing-down legs) 32" x 15" | 3.31 | 28  | 676.00   | 703.10            | 703.10                   |  |
| SSB2-420200 | BENCH STYLE SHOWER SEAT (with swing-down legs) 42" x 20" | 8.00 | 39  | 855.05   | -                 | 1,046.35                 |  |
| SSB2-480240 | BENCH STYLE SHOWER SEAT (with swing-down legs) 48" x 24" | 8.00 | 53  | 1,091.00 | -                 | 1,231.50                 |  |

SEACHROME CAN MANUFACTURE CUSTOM SIZE SEATS TO MEET ANY NEED - CONTACT US FOR INFORMATION



**SIGNATURE SERIES - ADA ACCESSIBILITY SHOWER SEATS**

MADE IN THE U.S.A

| SEAT TOP MATERIAL OPTIONS |                    |                   |                   |                     |  |
|---------------------------|--------------------|-------------------|-------------------|---------------------|--|
| ONE-PIECE SOLID PHENOLIC  |                    | 3" PHENOLIC SLATS |                   | OTHER               |  |
| PAS ALMOND                | PRTS RUSTIC TEAK   | PA ALMOND         | PRT RUSTIC TEAK   | NA NAUGAHYDE ALMOND |  |
| PAAS AGED ASH             | PTS TEAK           | PAA AGED ASH      | PT TEAK           | NW NAUGAHYDE WHITE  |  |
| PBS BLACK                 | PWAS WEATHERED ASH | PB BLACK          | PWA WEATHERED ASH |                     |  |
| PGS GREY                  | PWS WHITE          | PG GREY           | PW WHITE          |                     |  |
| PLGS LIGHT GREY           |                    | PLG LIGHT GREY    |                   |                     |  |

All Seachrome seats meet Federal Specification WW-P-541/8b and all ADA code requirements (250 lbs. of force) when properly installed.

Lift-Assist



All Seachrome seats meet ADA Code Operation 309.4 which requires 5 lbs. of force or less to lift the seat

For EXTRA HEAVY load requirements, select SSR2, SSL2, or SSB2 Models, which have been tested to withstand 1,000 lbs. of force when properly installed.



SSL-260225-NW



SSR-260225-PWS



SSR-320225-PT

| TRANSFER SEATS |                                     |      |     |         |                           |
|----------------|-------------------------------------|------|-----|---------|---------------------------|
| ITEM#W         | DESCRIPTION                         | CUBE | LBS | NA / NW | PHENOLIC SEAT TOP OPTIONS |
| SSL-260225     | LH L-SHAPED SHOWER SEAT 26" x 22.5" | 3.31 | 24  | 550.90  | 590.55                    |
| SSR-260225     | RH L-SHAPED SHOWER SEAT 26" x 22.5" | 3.31 | 24  | 550.90  | 590.55                    |
| SSL-280225     | LH L-SHAPED SHOWER SEAT 28" x 22.5" | 3.31 | 24  | 565.90  | 604.40                    |
| SSR-280225     | RH L-SHAPED SHOWER SEAT 28" x 22.5" | 3.31 | 24  | 565.90  | 604.40                    |
| SSL-320225     | LH L-SHAPED SHOWER SEAT 32" x 22.5" | 3.31 | 25  | 581.20  | 618.35                    |
| SSR-320225     | RH L-SHAPED SHOWER SEAT 32" x 22.5" | 3.31 | 25  | 581.20  | 618.35                    |



SSL2-320225-PWS



SSR2-320225-NW

| TRANSFER SEATS WITH SWING DOWN LEGS |  |      |     |         |                   |                          |
|-------------------------------------|--|------|-----|---------|-------------------|--------------------------|
| ITEM#                               | DESCRIPTION  | CUBE | LBS | NA / NW | 3" PHENOLIC SLATS | ONE-PIECE SOLID PHENOLIC |
| SSL2-260225                         | LH L-SHAPED SHOWER SEAT (with swing-down legs) 26" x 22.5" | 3.22 | 26  | 660.35  | 696.50            | 696.50                   |
| SSR2-260225                         | RH L-SHAPED SHOWER SEAT (with swing-down legs) 26" x 22.5" | 3.22 | 26  | 660.35  | 696.50            | 696.50                   |
| SSL2-280225                         | LH L-SHAPED SHOWER SEAT (with swing-down legs) 28" x 22.5" | 3.22 | 27  | 673.85  | 709.60            | 709.60                   |
| SSR2-280225                         | RH L-SHAPED SHOWER SEAT (with swing-down legs) 28" x 22.5" | 3.22 | 27  | 673.85  | 709.60            | 709.60                   |
| SSL2-320225                         | LH L-SHAPED SHOWER SEAT (with swing-down legs) 32" x 22.5" | 3.22 | 28  | 688.85  | 722.70            | 722.70                   |
| SSR2-320225                         | RH L-SHAPED SHOWER SEAT (with swing-down legs) 32" x 22.5" | 3.22 | 28  | 688.85  | 722.70            | 722.70                   |
| SSL2-360225                         | LH L-SHAPED SHOWER SEAT (with swing-down legs) 36" x 22.5" | 3.22 | 32  | 703.70  | -                 | 739.35                   |
| SSR2-360225                         | RH L-SHAPED SHOWER SEAT (with swing-down legs) 36" x 22.5" | 3.22 | 32  | 703.70  | -                 | 739.35                   |
| SSL2-420225                         | LH L-SHAPED SHOWER SEAT (with swing-down legs) 42" x 22.5" | 3.22 | 38  | 698.10  | -                 | 765.75                   |
| SSR2-40225                          | RH L-SHAPED SHOWER SEAT (with swing-down legs) 42" x 22.5" | 3.22 | 38  | 698.10  | -                 | 765.75                   |

SEACHROME SHOWER AND TUB SEATS MEET ALL REQUIREMENTS FOR ADA COMPLIANCE. INCLUDING ADA CODE 309.4 WHICH REQUIRES 5 LBS. OF FORCE OR LESS TO LIFT THE SEAT.

**SIGNATURE SERIES - PORTABLE FREE STANDING SEATS, BARIATRIC & INSTITUTIONAL SEATS**  
 MADE IN THE U.S.A

| SEAT TOP MATERIAL OPTIONS |            |      |               |
|---------------------------|------------|------|---------------|
| ONE-PIECE SOLID PHENOLIC  |            |      |               |
| PAS                       | ALMOND     | PRTS | RUSTIC TEAK   |
| PAAS                      | AGED ASH   | PTS  | TEAK          |
| PBS                       | BLACK      | PWAS | WEATHERED ASH |
| PGS                       | GREY       | PWS  | WHITE         |
| PLGS                      | LIGHT GREY |      |               |



SSPB-265148

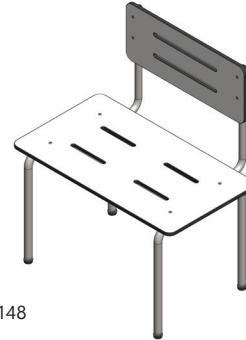

SSPC-265148

| PORTABLE FREE STANDING BENCH/SEAT |  |      |     |                          |
|-----------------------------------|--|------|-----|--------------------------|
| ITEM#                             | DESCRIPTION  | CUBE | LBS | ONE-PIECE SOLID PHENOLIC |
| SSPB-265148                       | PORTABLE FREE STANDING SHOWER BENCH, 26.5"W x 14.875"D x 18"H, SATIN STAINLESS STEEL FRAME | 4.1  | 20  | 308.90                   |
| SSPC-265148                       | PORTABLE FREE STANDING SHOWER CHAIR, 26.5"W x 14.875"D x 32"H, SATIN STAINLESS STEEL FRAME | 7.2  | 25  | 457.40                   |



SBB3-360180-PWS

Seachrome Institutional, Bariatric & Stationary Bench Seats have been tested to withstand over 1,200 lbs of force when properly installed.

| BARIATRIC BENCH SEATS |  |      |     |                          |
|-----------------------|--|------|-----|--------------------------|
| ITEM#                 | DESCRIPTION  | CUBE | LBS | ONE-PIECE SOLID PHENOLIC |
| SBB3-360180           | BARIATRIC BENCH SEAT (WITH SWING DOWN LEGS), 36" x 18" | 7.00 | 40  | 1,065.20                 |



SRDY-320225-SS



SBDYL-320150-SS

| INSTITUTIONAL BENCH SEATS |   |      |     |                               |
|---------------------------|---|------|-----|-------------------------------|
| ITEM#                     | DESCRIPTION   | CUBE | LBS | STAINLESS STEEL (SS) SEAT TOP |
| SLDY-320225               | LH TRANSFER SEAT (WITH DUAL YOKE), 32" x 22.5" ONE-PIECE STAINLESS STEEL SEAT TOP | 3.31 | 32  | 1,473.95                      |
| SRDY-320225               | RH TRANSFER SEAT (WITH DUAL YOKE), 32" x 22.5" ONE-PIECE STAINLESS STEEL SEAT TOP | 3.31 | 32  | 1,473.95                      |
| SBDY**L/R 320150          | BENCH SEAT (WITH DUAL YOKE), 32" x 15" ONE-PIECE STAINLESS STEEL SEAT TOP         | 3.31 | 32  | 1,473.95                      |

\*\*Left/Right Determines Hole Location For Safety Wall Clasp

**SIGNATURE SERIES - STATIONARY BENCHES - SHOWER SEAT COMPONENT ITEMS**

MADE IN THE U.S.A

| SEAT TOP MATERIAL OPTIONS |            |      |               |                   |            |     |               |       |                  |
|---------------------------|------------|------|---------------|-------------------|------------|-----|---------------|-------|------------------|
| ONE-PIECE SOLID PHENOLIC  |            |      |               | 3" PHENOLIC SLATS |            |     |               | OTHER |                  |
| PAS                       | ALMOND     | PRTS | RUSTIC TEAK   | PA                | ALMOND     | PRT | RUSTIC TEAK   | NA    | NAUGAHYDE ALMOND |
| PAAS                      | AGED ASH   | PTS  | TEAK          | PAA               | AGED ASH   | PT  | TEAK          | NW    | NAUGAHYDE WHITE  |
| PBS                       | BLACK      | PWAS | WEATHERED ASH | PB                | BLACK      | PWA | WEATHERED ASH |       |                  |
| PGS                       | GREY       | PWS  | WHITE         | PG                | GREY       | PW  | WHITE         |       |                  |
| PLGS                      | LIGHT GREY |      |               | PLG               | LIGHT GREY |     |               |       |                  |



SSBB-420200-PTS

| STATIONARY BENCH SEATS |   |     |                          |
|------------------------|---|-----|--------------------------|
| ITEM#                  | DESCRIPTION                                       | LBS | ONE-PIECE SOLID PHENOLIC |
| SSBB-420200            | STATIONARY BENCH SEAT (WITH BACK REST), 42" x 20" | 125 | 1,352.30                 |
| SSBB-480240            | STATIONARY BENCH SEAT (WITH BACK REST), 48" x 24" | 145 | 1,548.25                 |
| SSBS-420200            | STATIONARY BENCH SEAT (NO BACK REST), 42" x 20"   | 90  | 1,125.00                 |

| ACCESSIBILITY SEATS - COMPONENT ITEMS |   |            |               |   |       |
|---------------------------------------|---|------------|---------------|---|-------|
| ITEM#                                 | DESCRIPTION   | PRICE      | ITEM#         | DESCRIPTION   | PRICE |
|                                       | POWDER COAT (PC) SEAT FRAME   | ADD 260.00 | P-GB-SS       | GUIDE BRACKET FOR WALL MOUNT SEATS, STAINLESS STEEL, EACH (WITH HARDWARE)                                       | 30.00 |
|                                       | POLISHED STAINLESS (PS) SEAT FRAME  | ADD 360.00 | P-4C10-2      | #10 x 2-1/2" STAINLESS STEEL MOUNTING SCREWS FOR GRAB BARS  | 3.00  |
| SA-0022-SS                            | 2-1/2" LEG EXTENSION FOR USE WITH 2-SDL SERIES SHOWER SEAT STAINLESS STEEL/BLACK, EACH  | 51.00      | S-4500-110068 | #12 x 2-1/2" STAINLESS STEEL MOUNTING SCREWS FOR SEATS AND SWING-UP BARS. EACH PACK CONTAINS 3 MOUNTING SCREWS. | 3.00  |
| SA-0027-SS                            | 4" SEAT LEG EXTENSION FOR USE WITH 2-SDL SERIES SHOWER SEAT STAINLESS STEEL/BLACK, EACH | 64.00      | P-WSH-SS      | WALL-MOUNT SUPPORT HOOK STAINLESS STEEL, EACH   | 43.00 |
| SA-0028-SS                            | 5" SEAT LEG EXTENSION FOR USE WITH 2-SDL SERIES SHOWER SEAT STAINLESS STEEL/BLACK, EACH | 79.00      |               |   |       |



P-B180135-NW



P-L260210-NW

| REPLACEMENT SEAT TOPS - BENCH SEATS |                                 |        | REPLACEMENT SEAT TOPS - TRANSFER SEATS |                                 |           |
|-------------------------------------|---------------------------------|--------|--|---------------------------------|-----------|
|                                     | <b>NA/NW CUSHION</b>            |        |  | <b>NA/NW CUSHION</b>            |           |
|                                     | 18"-22"-24" WIDE x 13.5"        | 225.00 |  | 26"-28"-32" WIDE x 21"          | 275.00    |
|                                     | 26"-28"-32" WIDE x 13.5"        | 260.00 |  |                                 |           |
|                                     | <b>ONE-PIECE SOLID PHENOLIC</b> |        |  | <b>ONE-PIECE SOLID PHENOLIC</b> |           |
|                                     | 18"-22"-24" WIDE x 13.5"        | 245.00 |  | 26"-28"-32" WIDE x 21"          | 290.00    |
|                                     | 26"-28"-32" WIDE x 13.5"        | 270.00 |  |                                 |           |
|                                     |                                 |        |  | CUSTOM "WAVE" SLOTS             | ADD 60.00 |

**ACCESSIBILITY SEATS - ADDITIONAL NOTES**

Seachrome recommends that all accessibility seats, as well as grab bars, be installed using 2" minimum thickness "in-wall" solid wood backing material with the appropriate stainless steel, phillips head screws (included).

**SIGNATURE SERIES - TUB SEATS**

MADE IN THE U.S.A

| SEAT TOP MATERIAL OPTIONS |            |      |               |                   |            |     |               |       |                            |
|---------------------------|------------|------|---------------|-------------------|------------|-----|---------------|-------|----------------------------|
| ONE-PIECE SOLID PHENOLIC  |            |      |               | 3" PHENOLIC SLATS |            |     |               | OTHER |                            |
| PAS                       | ALMOND     | PRTS | RUSTIC TEAK   | PA                | ALMOND     | PRT | RUSTIC TEAK   | HW    | WHITE HDPE ONE-PIECE SOLID |
| PAAS                      | AGED ASH   | PTS  | TEAK          | PAA               | AGED ASH   | PT  | TEAK          | MW    | MOLDED WHITE HDPE PLASTIC  |
| PBS                       | BLACK      | PWAS | WEATHERED ASH | PB                | BLACK      | PWA | WEATHERED ASH | NA    | NAUGAHYDE ALMOND           |
| PGS                       | GREY       | PWS  | WHITE         | PG                | GREY       | PW  | WHITE         | NW    | NAUGAHYDE WHITE            |
| PLGS                      | LIGHT GREY |      |               | PLG               | LIGHT GREY |     |               | TWA   | TEAK WOOD SLATS            |

All Seachrome seats meet Federal Specification WW-P-541/8b and all ADA code requirements (250 lbs. of force) when properly installed.



| TUB SEATS   |   |      |     |        |         |                   |                          |        |
|-------------|---|------|-----|--------|---------|-------------------|--------------------------|--------|
| ITEM#       | DESCRIPTION   | CUBE | LBS | MW     | NA / NW | 3" PHENOLIC SLATS | ONE-PIECE SOLID PHENOLIC | TWA    |
| STE-320135  | HERMOSA FOLDING TUB SEAT, 32" x 13.5" FRAMELESS                         | 2.13 | 13  | -      |         |                   | 382.50                   | -      |
| STE1-320135 | HERMOSA FOLDING TUB SEAT, 32" x 13.5" WITH SATIN STAINLESS STEEL FRAME  | 2.13 | 16  | -      | 430.05  | 438.80            | 438.80                   | 650.00 |
| STE-320160  | HERMOSA FOLDING TUB SEAT, 32" x 16" FRAMELESS                           | 2.20 | 17  | -      |         |                   | 402.30                   | -      |
| STE1-320160 | HERMOSA FOLDING TUB SEAT, 32" x 16" WITH SATIN STAINLESS STEEL FRAME    | 2.20 | 20  | -      | 430.05  |                   | 454.85                   | 635.00 |
| STR-290165  | CATALINA FOLDING TUB SEAT, 29" x 16.5" FRAMELESS                        | 2.13 | 16  | -      |         |                   | 413.50                   |        |
| STR1-290165 | CATALINA FOLDING TUB SEAT, 29" x 16.5" WITH SATIN STAINLESS STEEL FRAME | 2.13 | 19  | -      | 462.20  | 488.85            | 413.50                   | 635.00 |
| TFRS-290150 | MALIBU REMOVABLE TRI-FOLD TUB SEAT, 29" x 15"                           | 2.13 | 12  | 194.45 | -       | -                 | -                        | 290.00 |



| PORTABLE TUB SEATS |  |      |     |                          |
|--------------------|--|------|-----|--------------------------|
| ITEM#              | DESCRIPTION  | CUBE | LBS | ONE-PIECE SOLID PHENOLIC |
| STPQ-265160        | REDONDO PORTABLE TUB SEAT, 26.5" x 16" WITH ADJUSTABLE LEGS & CLAMP                | 2.13 | 14  | 449.10                   |
| STPQ2-435150       | REDONDO PORTABLE TUB SEAT, 43.5" x 15" WITH DUAL FOLD DOWN ADJUSTABLE LEGS & CLAMP | 3.54 | 25  | 751.90                   |
| SHPQ-265150        | VENTURA PORTABLE TUB SEAT, 26.5" x 15" WITH DUAL CLAMPS & QUICK RELEASE PIN        | 2.50 | 20  | 688.60                   |

SEACHROME SHOWER AND TUB SEATS MEET ALL REQUIREMENTS FOR ADA COMPLIANCE, INCLUDING ADA CODE 309.4 WHICH REQUIRES 5 LBS. OF FORCE OR LESS TO LIFT THE SEAT.

**LIFESTYLE & WELLNESS SERIES - TUB/SHOWER SEATS**

MADE IN THE U.S.A

| SEAT TOP MATERIAL OPTIONS |            |      |                   |     |            |       |               |     | FINISH OPTIONS   |                 |                    |
|---------------------------|------------|------|-------------------|-----|------------|-------|---------------|-----|------------------|-----------------|--------------------|
| ONE-PIECE SOLID PHENOLIC  |            |      | 3" PHENOLIC SLATS |     |            | OTHER |               |     | PS               | POLISHED FINISH |                    |
| PAS                       | ALMOND     | PRTS | RUSTIC TEAK       | PA  | ALMOND     | PRT   | RUSTIC TEAK   | TWA | TEAK WOOD        | SS              | SATIN FINISH       |
| PAAS                      | AGED ASH   | PTS  | TEAK              | PAA | AGED ASH   | PT    | TEAK          | NA  | NAUGAHYDE ALMOND | PC              | POWDER COAT FINISH |
| PBS                       | BLACK      | PWAS | WEATHERED ASH     | PB  | BLACK      | PWA   | WEATHERED ASH | NW  | NAUGAHYDE WHITE  |                 |                    |
| PGS                       | GREY       | PWS  | WHITE             | PG  | GREY       | PW    | WHITE         |     |                  |                 |                    |
| PLGS                      | LIGHT GREY |      |                   | PLG | LIGHT GREY |       |               |     |                  |                 |                    |



BRIDGEPORT REMOVABLE TUB SEAT  
STSB-270155-PWS



CONTOUR SHOWER SEAT  
SSC-180180-PWS



PROFILE BENCH SEAT & 18" GRAB BAR  
SSGBH-180160-PT



BRIDGEPORT REMOVABLE TUB SEAT  
STSB-300150-TWA



| PROFILE & CONTOUR SHOWER SEATS / BRIDGEPORT REMOVABLE TUB SEAT |   |        |                   |                          |        |
|--|---|--------|-------------------|--------------------------|--------|
| ITEM#  | DESCRIPTION   | NW/NA  | 3" PHENOLIC SLATS | ONE-PIECE SOLID PHENOLIC | TWA    |
| SSGBH-180160   | HANGING PROFILE BENCH SEAT WITH LEGS & 18-INCH SATIN GRAB BAR INCLUDED, 18"W x 20-5/8"D, 1-1/4" O.D. SATIN FRAME                            |        | 638.85            | 638.85                   | -      |
| SSC-180180   | CONTOUR SHOWER SEATS 26-1/2"W x 16-1/2"D, ONE-PIECE SOLID PHENOLIC SEAT WITH STANDARD DRAIN SLOTS, 18" RADIUS CLEAR COATED ALUMINUM FRAME** |        | -                 | 202.45                   | -      |
| STSB-270155  | BRIDGEPORT REMOVABLE TUB SEAT 27" x 15-1/2", WITH ADJUSTABLE STABILIZING POSTS & 1-INCH SATIN FRAME   |        | -                 | 366.40                   | 437.00 |
| STSB-300150  | BRIDGEPORT REMOVABLE TUB SEAT 30" x 15" WITH ADJUSTABLE STABILIZING POSTS & 1-INCH SATIN FRAME  | 370.00 | -                 | 395.70                   | 475.00 |



SHSLI-185155-TWA-SS



SHSLI-185155-TWA-PS



SHSLI-185155-TWA-BSG

| CAMEO BENCH SEAT |   |          |          |           |
|------------------|---|----------|----------|-----------|
| ITEM#            | DESCRIPTION   | SS FRAME | PS FRAME | BSG FRAME |
| SHSLI-185155-TWA | CAMEO BENCH SEAT 18-3/4"W X 15-1/4"D WITH 15-3/4" REMOVABLE HIGH BACKREST WITH 3" NATURAL TEAK WOOD SLATS | 500.00   | 530.00   | 530.00    |

**LIFESTYLE & WELLNESS® SERIES - SILHOUETTE SLIMLINE SHOWER SEATS**

MADE IN THE U.S.A

| SEAT TOP MATERIAL OPTIONS |            |       |               |
|---------------------------|------------|-------|---------------|
| ONE-PIECE SOLID PHENOLIC  |            | OTHER |               |
| PAS                       | ALMOND     | PRTS  | RUSTIC TEAK   |
| PAAS                      | AGED ASH   | PTS   | TEAK          |
| PBS                       | BLACK      | PWAS  | WEATHERED ASH |
| PGS                       | GREY       | PWS   | WHITE         |
| PLGS                      | LIGHT GREY |       |               |

| POWDER COAT OPTIONS |             |
|---------------------|-------------|
| AL=                 | ALMOND      |
| BI=                 | BISCUIT     |
| BK=                 | BLACK       |
| BR=                 | BRONZE      |
| DB=                 | DARK BRONZE |
| MB=                 | MATTE BLACK |
| MWT=                | MATTE WHITE |
| SL=                 | SILVER      |
| WT=                 | WHITE       |

All powder coat frame options are available even if picture is not listed.  
Choose Seat Top AND Powder Coat Frame Options.

**ONE-PIECE SOLID PHENOLIC**



SHAFSL-185155-PBS-S-SL



SHAFSL-185155-PBS-S-MB



SHAFSL-185155-PBS-S-WT



SHAFSL-185155-PWS-S-SL



SHAFSL-185155-PWS-S-MB



SHAFSL-185155-PWS-S-WT



SHAFSL-185155-PAS-S-BR



SHAFSL-185155-PGS-S-SL



SHAFSL-185155-PGS-S-MB



SHAFSL-185155-PLGS-S-SL



SHAFSL-185155-PLGS-S-MB



SHAFSL-185155-PWAS-S-SL



SHAFSL-185155-PWAS-S-MB



SHAFSL-185155-PAAS-S-SL



SHAFSL-185155-PAAS-S-MB



SHAFSL-185155-PTS-S-SL



SHAFSL-185155-PTS-S-MB



SHAFSL-185155-PRTS-S-SL



SHAFSL-185155-PRTS-S-MB

**NATURAL TEAK WOOD**



SHAFSL-185155-TWA-SL



SHAFSL-185155-TWA-MB



SHAFSL-185155-TWA-SL

| SILHOUETTE SLIMLINE SHOWER SEATS |  |        |
|----------------------------------|--|--------|
| ITEM#                            | DESCRIPTION  | PRICE  |
| SHAFSL-185155-PHENOLIC           | 18-1/8" L x 15.86" D WITH 1/2" ONE-PIECE SOLID PHENOLIC SEAT TOP & ALUMINUM EXTRUDED FRAME WITH STANDARD DRAIN SLOTS | 360.00 |
| SHAFSL-185155-TWA                | 18-1/8" L x 14.55" D WITH 3" NATURAL TEAK WOOD SLATS SEAT TOP & ALUMINUM EXTRUDED FRAME                              | 590.20 |

Seachrome Silhouette Shower Seats meet Federal Specification WW-P-541/8b and all ADA code requirements (250 lbs. of force) when properly installed. Seachrome recommends a minimum 2" solid wood in-wall backing for all shower seat installations.

**LIFESTYLE & WELLNESS® SERIES - SILHOUETTE SHOWER SEATS**

MADE IN THE U.S.A

| SEAT TOP MATERIAL OPTIONS |            |       |               |
|---------------------------|------------|-------|---------------|
| ONE-PIECE SOLID PHENOLIC  |            | OTHER |               |
| PAS                       | ALMOND     | PRTS  | RUSTIC TEAK   |
| PAAS                      | AGED ASH   | PTS   | TEAK          |
| PBS                       | BLACK      | PWAS  | WEATHERED ASH |
| PGS                       | GREY       | PWS   | WHITE         |
| PLGS                      | LIGHT GREY |       |               |

| POWDER COAT OPTIONS |             |
|---------------------|-------------|
| AL=                 | ALMOND      |
| BI=                 | BISCUIT     |
| BK=                 | BLACK       |
| BR=                 | BRONZE      |
| DB=                 | DARK BRONZE |
| MB=                 | MATTE BLACK |
| MWT=                | MATTE WHITE |
| SL=                 | SILVER      |
| WT=                 | WHITE       |

All powder coat frame options are available even if picture is not listed.

Choose Seat Top AND Powder Coat Frame Options.

Silhouette Shower Seats feature an easy to remove backrest to allow cleaning of the shower wall behind the seat.



SHAF-185155-PBS-S-SL



SHAF-185155-PBS-S-MB



SHAF-185155-PBS-S-WT



SHAF-185155-PTS-S-SL



SHAF-185155-PTS-S-MB



SHAF-185155-PWS-S-SL



SHAF-185155-PWS-S-MB



SHAF-185155-PWS-S-WT



SHAF-185155-PRTS-S-SL



SHAF-185155-PRTS-S-MB



SHAF-185155-PGS-S-SL



SHAF-185155-PGS-S-MB



SHAF-185155-PAS-S-BR



SHAF-185155-TWA-S-SL



SHAF-185155-TWA-S-MB



| SILHOUETTE HIGH BACK SHOWER SEATS |  |          |        |
|-----------------------------------|--|----------|--------|
| ITEM#                             | DESCRIPTION  | PHENOLIC | TWA    |
| SHAF-185155                       | 19-3/8"W x 15-1/2"D WITH 14-3/4"H REMOVABLE HIGH BACKREST WITH 1/2" PHENOLIC SEAT TOP & ALUMINUM EXTRUDED FRAME      | 600.00   |        |
| SHAF-185155                       | 19-3/8"W x 15-1/2"D WITH 14-3/4"H REMOVABLE HIGH BACKREST WITH 3" TEAK WOOD SLATS SEAT TOP & ALUMINUM EXTRUDED FRAME |          | 825.00 |

| SEAT PAD COLOR OPTIONS |             |
|------------------------|-------------|
| AL - ALMOND            | SL - SILVER |
| BK - BLACK             | WT - WHITE  |



SHAFSL-185155-PGS-S-SL  
600008-BK



AL - ALMOND



SL - SILVER



BK - BLACK



WT - WHITE



SHAF-185155-PGS-S-SL  
600008-SL

| SEAT PAD - ONLY FOR SILHOUETTE SEATS |   |        |
|--------------------------------------|---|--------|
| ITEM#                                | DESCRIPTION   | PRICE  |
| 600008                               | 16-1/8"W x 11"D SEAT PAD FOR ADDED SEATING COMFORT, COMPATIBLE WITH SLIMLINE, SILHOUETTE & COMFORT SHOWER SEATS | 95.00  |
| 600052                               | 19-3/8"W x 11.69"D SEAT PAD FOR ADDED SEATING COMFORT, COMPATIBLE WITH COMFORT PLUS SHOWER SEATS                | 110.00 |

Seachrome Silhouette Shower Seats meet Federal Specification WW-P-541/8b and all ADA code requirements (250 lbs. of force) when properly installed. Seachrome recommends a minimum 2" solid wood in-wall backing for all shower seat installations.

**LIFESTYLE & WELLNESS® SERIES - SILHOUETTE SHOWER SEATS AND SEAT PADS**

MADE IN THE USA

| SEAT TOP MATERIAL OPTIONS |            |      |               |
|---------------------------|------------|------|---------------|
| ONE-PIECE SOLID PHENOLIC  |            |      |               |
| PAS                       | ALMOND     | PRTS | RUSTIC TEAK   |
| PAAS                      | AGED ASH   | PTS  | TEAK          |
| PBS                       | BLACK      | PWAS | WEATHERED ASH |
| PGS                       | GREY       | PWS  | WHITE         |
| PLGS                      | LIGHT GREY |      |               |

| POWDER COAT OPTIONS |             |      |             |
|---------------------|-------------|------|-------------|
| AL=                 | ALMOND      | MB=  | MATTE BLACK |
| BI=                 | BISCUIT     | MWT= | MATTE WHITE |
| BK=                 | BLACK       | SL=  | SILVER      |
| BR=                 | BRONZE      | WT=  | WHITE       |
| DB=                 | DARK BRONZE |      |             |

All powder coat frame options are available even if picture is not listed.

Choose Seat Top AND Powder Coat Frame Options.



SHAFAR-185155-PWS-S-WT-WT



SHAFAR-185155-PWS-S-SL-SL



SHAFAR-185155-PWS-S-BK-BK



SHAFAR-185155-PBS-S-MB-MB



SHAFAR-185155-PGS-S-SL-SL



SHAFAR-185155-PGS-S-MB-MB



SHAFAR-185155-PTS-S-SL-SL



SHAFAR-185155-PTS-S-MB-MB

| SILHOUETTE COMFORT SHOWER SEATS |   |        |
|---------------------------------|---|--------|
| ITEM#                           | DESCRIPTION   | PRICE  |
| SHAFAR-185155                   | SILHOUETTE COMFORT SHOWER SEAT 23-1/2"W x 16"D WITH 12-3/4"H REMOVABLE BACKREST AND PADDED ARMS, WITH 1/2" SEAT TOP & ALUMINUM EXTRUDED FRAME WITH STANDARD DRAIN SLOTS | 790.00 |



SHAFB-240155-PWS-S-WT-WT



SHAFB-240155-PBS-S-BK-BK

Silhouette Comfort Plus Shower Seats with Padded Arms and Fold-Down Legs are rated to 800 lbs. weight limit when properly installed.

Also have seat height adjustability from 15" to 22".



| SILHOUETTE COMFORT PLUS SHOWER SEATS |   |          |
|--------------------------------------|---|----------|
| ITEM#                                | DESCRIPTION   | PRICE    |
| SHAFB-240155                         | SILHOUETTE COMFORT PLUS SHOWER SEAT WITH PADDED ARMS AND FOLD-DOWN LEGS, 27"W x 16"D WITH 15"H REMOVABLE BACKREST, WITH 1/2" SEAT TOP & ALUMINUM EXTRUDED FRAME WITH STANDARD DRAIN SLOTS | 1,112.25 |



**LIFESTYLE & WELLNESS SERIES - SHOWER SHELVES**

MADE IN THE USA

| MATERIAL OPTIONS         |            |      |               | POWDER COAT (PC) OPTIONS |           |     |                  | FINISH OPTIONS |                |    |                    |
|--------------------------|------------|------|---------------|--------------------------|-----------|-----|------------------|----------------|----------------|----|--------------------|
| ONE-PIECE SOLID PHENOLIC |            |      |               | OTHER                    |           |     |                  |                |                |    |                    |
| PAS                      | ALMOND     | PRTS | RUSTIC TEAK   | TWA                      | TEAK WOOD | AL  | ALMOND           | MB             | MATTE BLACK    | PS | POLISHED FINISH    |
| PAAS                     | AGED ASH   | PTS  | TEAK          |                          |           | AW  | ALMOND WRINKLE   | MWT            | MATTE WHITE    | SS | SATIN FINISH       |
| PBS                      | BLACK      | PWAS | WEATHERED ASH |                          |           | BI  | BISCUIT          | PB             | POLISHED BRASS | PC | POWDER COAT FINISH |
| PGS                      | GREY       | PWS  | WHITE         |                          |           | BK  | BLACK            | SB             | SATIN BRASS    |    |                    |
| PLGS                     | LIGHT GREY |      |               |                          |           | BR  | BRONZE           | SN             | SATIN NICKEL   |    |                    |
|                          |            |      |               |                          |           | BSG | BLACK SEMI-GLOSS | WT             | WHITE          |    |                    |
|                          |            |      |               |                          |           | BW  | BLACK WRINKLE    | WW             | WHITE WRINKLE  |    |                    |
|                          |            |      |               |                          |           | DB  | DARK BRONZE      |                |                |    |                    |



W-SC300-0909-PS



SCS-090090-PWS



W-SC306-1406-PS

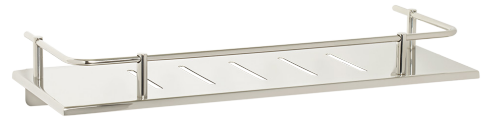

720-9016-PS

| SHOWER SHELVES |  |                |        |        |                            |  |
|----------------|--|----------------|--------|--------|----------------------------|--|
| ITEM#          | DESCRIPTION  | FINISH OPTIONS |        |        | SHELF TOP MATERIAL OPTIONS |  |
|                |  | SS             | PS     | PC     | ONE-PIECE PHENOLIC SOLID   |  |
| W-SC306-1406   | CORNER SHOWER SHELF, 14-1/8"W x 8-1/2"D WITH 14" HANDLE #304 STAINLESS STEEL   | 160.65         | 194.40 | 174.00 | -                          |  |
| W-SC300-0909   | CORNER SHOWER SHELF WITH RAIL, 13-1/4"W x 6-1/8"D #304 STAINLESS STEEL   | 129.10         | 161.90 | 147.60 | -                          |  |
| 720-9016       | 16" RECTANGULAR SUNDRIES SHELF WITH RAIL, 16"W x 6-1/8"D STAINLESS STEEL   | 158.90         | 213.70 | 184.85 | -                          |  |
| SCS-090090     | CONTOUR SHOWER SHELF, 12-5/8"W x 9"D, ONE-PIECE SOLID PHENOLIC WITH STANDARD DRAIN SLOTS, 18" RADIUS CLEAR COATED ALUMINUM FRAME** | -              | -      | -      | 127.20                     |  |

\*\*CONTOUR SHELF MATCHES CONTOUR SHOWER SEAT (SSC-180180) ON PAGE 24



700-7005-TWA-SS



700-7006-TWA-SS



700-7005-TWA-MB



700-7006-TWA-MB

| NATURAL TEAK WOOD SHOWER SHELVES |  |        |        |        |  |  |
|----------------------------------|--|--------|--------|--------|--|--|
| ITEM#                            | DESCRIPTION  | SS     | PS     | PC     |  |  |
| 700-7005-TWA                     | RECTANGULAR SHELF WITH RAIL, 18"W x 4"D #304 STAINLESS STEEL WITH NATURAL TEAK WOOD INSERT | 150.00 | 215.00 | 215.00 |  |  |
| 700-7006-TWA                     | CORNER SHOWER SHELF, 14.2"W x 7.9"D #304 STAINLESS STEEL WITH NATURAL TEAK WOOD INSERT     | 170.00 | 185.00 | 185.00 |  |  |

PLEASE CALL FOR PRICE & AVAILABILITY ON CUSTOM SIZES

**CORONADO SERIES - BATHROOM ACCESSORIES SHELVES**  
MADE IN THE U.S.A

| POWDER COAT (PC) OPTIONS |                  |     |                | 700 SERIES FEATURES                          |  | FINISH OPTIONS |                    |
|--------------------------|------------------|-----|----------------|--|--|----------------|--------------------|
| AL                       | ALMOND           | MB  | MATTE BLACK    | - 3/4" ROUND CROSSPIECE                      |  | PS             | POLISHED FINISH    |
| AW                       | ALMOND WRINKLE   | MWT | MATTE WHITE    | - 1" ROUND POST                              |  | SS             | SATIN FINISH       |
| BI                       | BISCUIT          | PB  | POLISHED BRASS | - 2-1/2" ROUND CONCEALED FLANGES             |  | PC             | POWDER COAT FINISH |
| BK                       | BLACK            | SB  | SATIN BRASS    | - AVAILABLE IN DECORATIVE STEP FLANGE DESIGN |  |                |                    |
| BR                       | BRONZE           | SN  | SATIN NICKEL   | 711 SERIES FEATURES                          |  |                |                    |
| BSG                      | BLACK SEMI-GLOSS | WT  | WHITE          | - 7/8" ROUND CROSSPIECE                      |  |                |                    |
| BW                       | BLACK WRINKLE    | WW  | WHITE WRINKLE  | - 7/8" ROUND POST                            |  |                |                    |
| DB                       | DARK BRONZE      |     |                | - 2-1/2" ROUND CONCEALED FLANGES             |  |                |                    |
|                          |                  |     |                | - AVAILABLE IN DECORATIVE STEP FLANGE DESIGN |  |                |                    |

FABRICATED OF TYPE #304, 18-8 ALLOY, STAINLESS STEEL RATED TO EXCEED 100-LBS LOAD CAPACITY WHEN PROPERLY INSTALLED

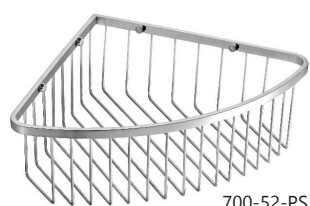

700-52-PS



700-7005-MB



700-7006-MB



700-54-PS



700-7005-SS



700-7006-PS

| CORONADO SERIES - SHOWER SHELVES |  |        |        |        |
|----------------------------------|--|--------|--------|--------|
| ITEM#                            | DESCRIPTION  | SS     | PS     | PC     |
| 700-52                           | SHOWER WIRE BASKET, 8" x 8" x 3.5", STAINLESS STEEL          | 49.65  | 58.45  | 58.45  |
| 700-54                           | SHOWER WIRE SOAP BASKET, 4" x 5.5" x 1", STAINLESS STEEL     | 27.50  | 31.50  | 31.50  |
| 700-7005                         | RECTANGULAR SHELF WITH RAIL, 18"W x 4"D #304 STAINLESS STEEL | 114.50 | 151.20 | 151.20 |
| 700-7006                         | CORNER SHOWER SHELF, 14.2"W x 7.9"D #304 STAINLESS STEEL     | 64.80  | 81.00  | 81.00  |



700-8018



700-8024

| ITEM#    | DESCRIPTION   | SS     | PS     | PC     |
|----------|---|--------|--------|--------|
| 700-8018 | 18" TOWEL SHELF AND BAR, 18" MOUNTING CENTERS x 9-1/4"D | 145.55 | 159.50 | 159.50 |
| 700-8024 | 24" TOWEL SHELF AND BAR, 24" MOUNTING CENTERS x 9-1/4"D | 152.30 | 176.25 | 176.25 |

**SIGNATURE SERIES - SHOWER RODS - FLANGES - SHOWER CURTAINS - CURTAIN RINGS**

MADE IN THE U.S.A

| POWDER COAT OPTIONS |                  |     |               | FINISH OPTIONS |                |    |                    |
|---------------------|------------------|-----|---------------|----------------|----------------|----|--------------------|
| AL                  | ALMOND           | BW  | BLACK WRINKLE | PB             | POLISHED BRASS | PS | POLISHED FINISH    |
| AW                  | ALMOND WRINKLE   | BR  | BRONZE        | SB             | SATIN BRASS    | SS | SATIN FINISH       |
| BI                  | BISCUIT          | DR  | DARK BRONZE   | SN             | SATIN NICKEL   | PC | POWDER COAT FINISH |
| BK                  | BLACK            | MB  | MATTE BLACK   | WT             | WHITE          |    |                    |
| BSG                 | BLACK SEMI-GLOSS | MWT | MATTE WHITE   | WW             | WHITE WRINKLE  |    |                    |



SR20-60.000

| 1" OD STAINLESS STEEL SHOWER RODS                               |              |  |  |       |       |        |
|---|--------------|--|--|-------|-------|--------|
| #304 STAINLESS STEEL SHOWER RODS 1" OD x 0.035" (20 GAUGE) WALL |              |  |  | PS    |       |        |
| SR20-36.000   | 36" STRAIGHT |  |  | 26.75 |       |        |
| SR20-48.000   | 48" STRAIGHT |  |  | 32.15 |       |        |
| SR20-60.000   | 60" STRAIGHT |  |  | 40.05 |       |        |
| SR20-72.000   | 72" STRAIGHT |  |  | 53.55 |       |        |
| #304 STAINLESS STEEL SHOWER RODS 1" OD x 0.049" (18 GAUGE) WALL |              |  |  | SS    | PS    | PC     |
| SR18-36.000   | 36" STRAIGHT |  |  | 31.25 | 34.65 | 65.05  |
| SR18-48.000   | 48" STRAIGHT |  |  | 37.40 | 43.70 | 75.15  |
| SR18-60.000   | 60" STRAIGHT |  |  | 46.75 | 54.55 | 89.35  |
| SR18-72.000   | 72" STRAIGHT |  |  | 62.15 | 72.45 | 107.85 |



| SHOWER ROD FLANGES FOR 1" DIAMETER RODS |  |  |  | SS    | PS    | PC    |
|---|--|--|--|-------|-------|-------|
| SCM-61-F (SRF-500)                      | CONCEALED FLANGE & HANGER, 2-1/2" DIAMETER, TRIPLE CHROME PLATED STEEL |  |  | -     | 6.60  | 10.25 |
| SCM-63-F (SRF-500MD)                    | EXPOSED SCREW, 2-1/4" DIAMETER, CHROME PLATED ZAMAC                    |  |  | -     | 8.20  | -     |
| SRF-510                                 | EXPOSED FLANGE, 22 GAUGE x 1/2" DEEP STAINLESS STEEL, 3" DIAMETER      |  |  | 10.70 | 11.25 | 19.75 |
| SCM-52-F (SRF-501)                      | ADJUSTABLE JIFFY-ON, POLISHED ALUMINUM FINISH                          |  |  | -     | 8.55  | -     |
| SCM-54-F (SRF-501C)                     | ADJUSTABLE JIFFY-ON, CHROME PLATED PLASTIC                             |  |  | -     | 2.60  | 4.05  |
| SRF-514                                 | CONCEALED FLANGE, 22 GAUGE SNAP-ON COVER, 3" DIAMETER                  |  |  | 18.50 | 21.60 | 37.80 |

| 1-1/4" OD STAINLESS STEEL SHOWER RODS                               |              |  |  |       |       |        |
|---|--------------|--|--|-------|-------|--------|
| #304 STAINLESS STEEL SHOWER RODS 1-1/4" OD x 0.049" (18 GAUGE) WALL |              |  |  | SS    | PS    | PC     |
| SR18Q-36.000  | 36" STRAIGHT |  |  | 39.00 | 46.00 | 75.05  |
| SR18Q-48.000  | 48" STRAIGHT |  |  | 46.80 | 55.20 | 87.10  |
| SR18Q-60.000  | 60" STRAIGHT |  |  | 65.70 | 79.80 | 104.25 |
| SR18Q-72.000  | 72" STRAIGHT |  |  | 71.60 | 84.45 | 120.20 |



| #304 STAINLESS STEEL SHOWER RODS 1-1/4" OD x 0.049" (18 GAUGE) WALL |   |  |  | SS    | PS    | PC    |
|---|---|--|--|-------|-------|-------|
| SRF-511   | EXPOSED FLANGE, 22 GAUGE x 1/2" DEEP STAINLESS STEEL, 3" DIAMETER |  |  | 9.40  | 11.00 | 19.40 |
| SRF-515   | CONCEALED FLANGE, 22 GAUGE SNAP-ON COVER, 3" DIAMETER             |  |  | 19.10 | 22.00 | 33.55 |

**SIGNATURE SERIES - SHOWER RODS - FLANGES - SHOWER CURTAINS - CURTAIN RINGS**  
**MADE IN THE U.S.A**

| POWDER COAT OPTIONS |                  |     |                | FINISH OPTIONS |               |    |                    |
|---------------------|------------------|-----|----------------|----------------|---------------|----|--------------------|
| AL                  | ALMOND           | BW  | BLACK WRINKLE  | SB             | SATIN BRASS   | PS | POLISHED FINISH    |
| AW                  | ALMOND WRINKLE   | BR  | BRONZE         | SN             | SATIN NICKEL  | SS | SATIN FINISH       |
| BI                  | BISCUIT          | MB  | MATTE BLACK    | WT             | WHITE         | PC | POWDER COAT FINISH |
| BK                  | BLACK            | MWT | MATTE WHITE    | WW             | WHITE WRINKLE |    |                    |
| BSG                 | BLACK SEMI-GLOSS | PB  | POLISHED BRASS |                |               |    |                    |



| #304 STAINLESS STEEL CURVED SHOWER RODS 1" OD x 0.035" (20 GAUGE) WALL     |   | PS    | PC     |        |
|--|---|-------|--------|--------|
| SR20-C60.000   | 60" CURVED (USE SRF-555 OR SRF-551 FLANGES)         | 59.15 | 134.50 |        |
| SR20-C72.000   | 72" CURVED (USE SRF-555 OR SRF-551 FLANGES)         | 70.40 | 145.05 |        |
| #304 STAINLESS STEEL CURVED SHOWER RODS 1" OD x 0.049" (18 GAUGE) WALL     |   | SS    | PS     | PC     |
| SR18-C60.000   | 60" CURVED (USE SRF-555 OR SRF-551 FLANGES)         | 59.65 | 66.85  | 134.50 |
| SR18-C72.000   | 72" CURVED (USE SRF-555 OR SRF-551 FLANGES)         | 74.80 | 83.10  | 145.05 |
| #304 STAINLESS STEEL SHOWER ROD FLANGES FOR 1" DIAMETER CURVED SHOWER RODS |   | SS    | PS     | PC     |
| SRF-555  | PIVOTING FLANGE (FOR 1" CURVED ROD)                 | 33.95 | 37.75  | -      |
| SRF-551  | FIXED FLANGE (FOR 1" CURVED ROD)                    | 27.90 | 30.95  | 43.35  |
| SRF-551CR  | FIXED FLANGE WITH SNAP ON COVER (FOR 1" CURVED ROD) | 73.80 | 96.35  | 96.35  |



| #304 STAINLESS STEEL L-SHAPED SHOWER RODS 1" OD x 0.049" (18 GAUGE) WALL |   | SS     | PS     | PC     |
|--|---|--------|--------|--------|
| SR18-L6036   | 60" x 36" L-SHAPED ROD WITH WELDED CONCEALED FLANGES (USE SR-CSJ24 CEILING SUPPORT)                             | 171.30 | 190.30 | 254.75 |
| SR18-L7236   | 72" x 36" L-SHAPED ROD WITH WELDED CONCEALED FLANGES (USE SR-CSJ24 CEILING SUPPORT)                             | 178.45 | 198.35 | 265.50 |
| SHOWER ROD FLANGES FOR 1" DIAMETER L-SHAPED SHOWER RODS                  |   | SS     | PS     | PC     |
| SRF-570  | STRAIGHT POST FLANGE FOR 1" SHOWER ROD WITH EXPOSED SCREWS  | 33.00  | 38.75  | 53.40  |
| SHOWER ROD CEILING SUPPORT FOR 1" DIAMETER L-SHAPED SHOWER RODS          |   | SS     | PS     | PC     |
| SR-CSJ24   | CEILING SUPPORT (FOR 1" L-SHAPED ROD) 24" HANGER WITH J-HOOK  | 34.45  | 40.65  | 66.25  |
| SHOWER CURTAINS (HEAVY DUTY 0.010" WHITE VINYL)                          |   |        |        | PRICE  |
| SHC-H04872-WU  | HEAVY-DUTY 48" x 72" WHITE CURTAIN WITH BRASS/NICKEL GROMMETS ON 6" CENTERS, UN-WEIGHTED (8 RINGS PER CURTAIN)  |        |        | 59.20  |
| SHC-H07272-WU  | HEAVY-DUTY 72" x 72" WHITE CURTAIN WITH BRASS/NICKEL GROMMETS ON 6" CENTERS, UN-WEIGHTED (12 RINGS PER CURTAIN) |        |        | 68.60  |
| SHOWER CURTAIN RINGS   |   |        |        | PRICE  |
| SRC-100-MT   | CURTAIN RING, NICKEL PLATED (EA.)   |        |        | 1.05   |
| SRC-100-SS   | CURTAIN RING, STAINLESS STEEL (EA.)   |        |        | 1.35   |

**CORONADO SERIES - BATHROOM ACCESSORIES - 700 & 711 SERIES**

MADE IN THE U.S.A

| POWDER COAT (PC) OPTIONS |                  |     |                |
|--------------------------|------------------|-----|----------------|
| AL                       | ALMOND           | MB  | MATTE BLACK    |
| AW                       | ALMOND WRINKLE   | MWT | MATTE WHITE    |
| BI                       | BISCUIT          | PB  | POLISHED BRASS |
| BK                       | BLACK            | SB  | SATIN BRASS    |
| BR                       | BRONZE           | SN  | SATIN NICKEL   |
| BSG                      | BLACK SEMI-GLOSS | WT  | WHITE          |
| BW                       | BLACK WRINKLE    | WW  | WHITE WRINKLE  |
| DB                       | DARK BRONZE      |     |                |

| 700 SERIES FEATURES                          |
|--|
| - 3/4" ROUND CROSSPIECE                      |
| - 1" ROUND POST                              |
| - 2-1/2" ROUND CONCEALED FLANGES             |
| - AVAILABLE IN DECORATIVE STEP FLANGE DESIGN |
| 711 SERIES FEATURES                          |
| - 7/8" ROUND CROSSPIECE                      |
| - 7/8" ROUND POST                            |
| - 2-1/2" ROUND CONCEALED FLANGES             |
| - AVAILABLE IN DECORATIVE STEP FLANGE DESIGN |

| FINISH OPTIONS |                    |
|----------------|--------------------|
| PS             | POLISHED FINISH    |
| SS             | SATIN FINISH       |
| PC             | POWDER COAT FINISH |



700-40-SS  
711-40-SS



700-41-2-MB  
711-41-2-MB



700-46-SS  
711-46-SS

700-40-PS  
711-40-PS



| 700 & 711 SERIES - CORONADO |                                       |       |       |       |  |
|-----------------------------|---------------------------------------|-------|-------|-------|--|
| ITEM#                       | DESCRIPTION                           | SS    | PS    | PC    |  |
| 700-40 / 711-40             | SINGLE ROBE HOOK, 2-1/2"W x 2-1/2"D   | 61.25 | 68.40 | 68.40 |  |
| 700-41-2 / 711-41           | DOUBLE ROBE HOOK, 3-1/2"W x 3-1/4"D   | 67.60 | 73.25 | 73.25 |  |
| 700-46 / 711-46             | TOWEL RING, 6-3/8" DIAMETER x 2-1/2"D | 79.70 | 90.80 | 90.80 |  |



700-00  
711-00



700-10  
711-10



700-13  
711-13



700-14

| ITEM#           | DESCRIPTION   | SS    | PS    | PC    |
|-----------------|---|-------|-------|-------|
| 700-00 / 711-00 | SOAP HOLDER (WITHOUT HOLES), 4-5/16" DIAMETER DISH                        | 67.10 | 77.00 | 77.00 |
| 700-10 / 711-10 | TOOTHBRUSH TUMBLER HOLDER, 4-5/16" DIAMETER DISH                          | 67.10 | 77.00 | 77.00 |
| 700-13 / 711-13 | DOOR BUMPER, 1-1/2" DIAMETER x 3"D, EXPOSED MOUNTING FLANGE               | 49.85 | 56.35 | 56.35 |
| 700-14 / 711-14 | DOOR BUMPER / COAT HANGER, 1-1/2" DIAMETER x 3"D, EXPOSED MOUNTING FLANGE | 54.75 | 62.20 | 62.20 |



700-31  
711-31



700-31-2  
711-31-2



700-33-R  
711-33-R



700-33-L  
711-33-R



700-33-2  
711-33-2



700-35  
711-35

| ITEM#               | DESCRIPTION   | SS     | PS     | PC     |
|---------------------|---|--------|--------|--------|
| 700-31 / 711-31     | SINGLE PAPER HOLDER, WHITE ROLLER, 6-1/2" MOUNTING CENTERS x 3-1/2"D  | 94.65  | 105.90 | 105.90 |
| 700-31-2 / 711-31-2 | DOUBLE PAPER HOLDER, WHITE ROLLER, 12-1/2" MOUNTING CENTERS x 3-1/2"D | 129.75 | 144.90 | 144.90 |
| 700-33-R / 711-33-R | RH "POST-STYLE" SINGLE PAPER HOLDER, 6" CENTER TO END x 4-1/8"D       | 126.55 | 144.55 | 144.55 |
| 700-33-L / 711-33-L | LH "POST-STYLE" SINGLE PAPER HOLDER, 6" CENTER TO END x 4-1/8"D       | 126.55 | 144.55 | 144.55 |
| 700-33-2 / 711-33-2 | "POST-STYLE" DOUBLE PAPER HOLDER, 11-1/2" OVERALL x 4-11/8"D          | 134.25 | 149.65 | 149.65 |
| 700-35 / 711-35     | RECTANGULAR PAPER / TOWEL HOLDER, 6-1/2"W x 5-1/2"H x 3-3/8"D         | 96.70  | 109.30 | 109.30 |

**CORONADO SERIES - BATHROOM ACCESSORIES - 700 & 711 SERIES**

MADE IN THE U.S.A

| POWDER COAT (PC) OPTIONS |                  |     |                | 700 SERIES FEATURES     |   | FINISH OPTIONS |                    |
|--------------------------|------------------|-----|----------------|-------------------------|---|----------------|--------------------|
| AL                       | ALMOND           | MB  | MATTE BLACK    | - 3/4" ROUND CROSSPIECE | - 1" ROUND POST<br>- 2-1/2" ROUND CONCEALED FLANGES<br>- AVAILABLE IN DECORATIVE STEP FLANGE DESIGN   | PS             | POLISHED FINISH    |
| AW                       | ALMOND WRINKLE   | MWT | MATTE WHITE    |                         |   | SS             | SATIN FINISH       |
| BI                       | BISCUIT          | PB  | POLISHED BRASS | 711 SERIES FEATURES     |   | PC             | POWDER COAT FINISH |
| BK                       | BLACK            | SB  | SATIN BRASS    |                         |   |                |                    |
| BR                       | BRONZE           | SN  | SATIN NICKEL   | - 7/8" ROUND CROSSPIECE | - 7/8" ROUND POST<br>- 2-1/2" ROUND CONCEALED FLANGES<br>- AVAILABLE IN DECORATIVE STEP FLANGE DESIGN |                |                    |
| BW                       | BLACK WRINKLE    | WT  | WHITE          |                         |   |                |                    |
| DB                       | BRONZE           | WW  | WHITE WRINKLE  |                         |   |                |                    |
| BSG                      | BLACK SEMI-GLOSS |     |                |                         |   |                |                    |



711-2018  
711-2024  
711-2030  
711-2036



| CORONADO SERIES - TOWEL BAR |  |        |        |        |
|-----------------------------|--|--------|--------|--------|
| ITEM#                       | DESCRIPTION  | SS     | PS     | PC     |
| 711-2018                    | 18" ONE-PIECE WELDED TOWEL BAR WITH 15" MOUNTING CENTERS | 125.20 | 151.80 | 151.80 |
| 711-2024                    | 24" ONE-PIECE WELDED TOWEL BAR WITH 21" MOUNTING CENTERS | 134.85 | 163.35 | 163.35 |
| 711-2030                    | 30" ONE-PIECE WELDED TOWEL BAR WITH 27" MOUNTING CENTERS | 142.70 | 171.20 | 171.20 |
| 711-2036                    | 36" ONE-PIECE WELDED TOWEL BAR WITH 33" MOUNTING CENTERS | 155.65 | 177.05 | 177.05 |



700-2018  
700-2024



700-2018-2  
700-2024-2



700-2030  
700-2036

| CORONADO SERIES - TOWEL BAR SETS |  |        |        |        |
|----------------------------------|--|--------|--------|--------|
| ITEM#                            | DESCRIPTION  | SS     | PS     | PC     |
| 700-2018                         | 18" TOWEL BAR SET (3/4" RD.), 18" MOUNTING CENTERS x 3-1/2" D        | 99.00  | 112.40 | 112.40 |
| 700-2018-2                       | 18" DOUBLE TOWEL BAR SET (3/4" RD.), 18" MOUNTING CENTERS x 6-3/4" D | 124.75 | 138.95 | 138.95 |
| 700-2024                         | 24" TOWEL BAR SET (3/4" RD.), 24" MOUNTING CENTERS x 3-1/2" D        | 105.50 | 119.35 | 119.35 |
| 700-2024-2                       | 24" DOUBLE TOWEL BAR SET (3/4" RD.), 24" MOUNTING CENTERS x 6-3/4" D | 131.90 | 146.80 | 146.80 |
| 700-2030                         | 30" TOWEL BAR SET (3/4" RD.), 30" MOUNTING CENTERS x 3-1/2" D        | 112.40 | 127.10 | 127.10 |



700-7004-PS



700-50-PS

| CORONADO SERIES - SHOWER FOOT REST |   |        |        |        |
|------------------------------------|---|--------|--------|--------|
| ITEM#                              | DESCRIPTION   | SS     | PS     | PC     |
| 700-7004                           | CORONADO SERIES SHOWER FOOT REST 13-3/8"W x 1" DIAMETER WITH 5-1/2" DIAMOND KNURLED CENTER #304 STAINLESS STEEL, INCLUDES MATCHING SCREW CAPS | 40.45  | 54.55  | 54.55  |
| 700-50                             | CORONADO SERIES SHOWER FOOT REST 15"W x 3.5" DIAMETER, 18 GAUGE STAINLESS STEEL TUBING  | 142.05 | 165.35 | 165.35 |

**BATHROOM ACCESSORIES - 15000 SERIES STAINLESS STEEL**

MADE IN THE U.S.A

| FINISH OPTIONS |                 |
|----------------|-----------------|
| PS             | POLISHED FINISH |
| SS             | SATIN FINISH    |

FABRICATED OF TYPE #304, 18-8 ALLOY, STAINLESS STEEL FOR HOTEL/MOTEL, HEALTHCARE, HOSPITALS, GOVERNMENT & COMMERCIAL PROJECTS.



15600



15601



15610

| 15000 SERIES - STAINLESS |   |          |          |       |       |
|--------------------------|---|----------|----------|-------|-------|
| ITEM#                    | DESCRIPTION   | CASE QTY | LBS/CASE | SS    | PS    |
| 15600                    | SOAP HOLDER WITHOUT DRAIN HOLES 4-1/4"W x 2-1/8"H x 4-1/4"D | 50       | 22       | 19.05 | 19.05 |
| 15601                    | SOAP HOLDER WITH DRAIN HOLES 4-1/4"W x 2-1/8"H x 4-1/4"D    | 50       | 21       | 19.05 | 19.05 |
| 15610                    | TOOTHBRUSH / TUMBLER HOLDER 4-1/4"W x 2"H x 4"D             | 50       | 18       | 19.05 | 19.05 |



15620-SQ-Series



15910-24



15620-RD-Series

| ITEM#      | DESCRIPTION   | CASE QTY | LBS/CASE | SS    | PS    |
|------------|---|----------|----------|-------|-------|
| 15620-18SQ | 18" SQUARE TOWEL BAR SET (3/4" SQ.), 18" END TO END | 100      | 75       | 38.70 | 38.70 |
| 15620-24SQ | 24" SQUARE TOWEL BAR SET (3/4" SQ.), 18" END TO END | 100      | 84       | 41.80 | 41.80 |
| 15620-30SQ | 30" SQUARE TOWEL BAR SET (3/4" SQ.), 18" END TO END | 100      | 89       | 45.25 | 45.25 |
| 15620-18RD | 18" ROUND TOWEL BAR SET (3/4" RD.), 18" END TO END  | 100      | 68       | 38.05 | 38.05 |
| 15620-24RD | 24" ROUND TOWEL BAR SET (3/4" RD.), 18" END TO END  | 100      | 75       | 39.60 | 39.60 |
| 15620-30RD | 30" ROUND TOWEL BAR SET (3/4" RD.), 18" END TO END  | 100      | 82       | 41.50 | 41.50 |
| 15910-24   | 24" TOWEL SHELF WITH BAR, 24" END TO END x 8-3/4"D  | 20       | 41       | 89.15 | 89.15 |



15631



15640



15642



15643



15631-2



15641



15646

| ITEM#   | DESCRIPTION  | CASE QTY | LBS/CASE | SS    | PS    |
|---------|--|----------|----------|-------|-------|
| 15631   | SINGLE PAPER HOLDER, PLASTIC SPRING LOADED WHITE ROLLER, 7-1/2"W x 2"H x 3-7/8"D | 60       | 35       | 30.40 | 30.40 |
| 15631-2 | DOUBLE PAPER HOLDER, PLASTIC SPRING LOADED WHITE ROLLER, 13"W x 2"H x 3-7/8"D    | 40       | 34       | 40.70 | 40.70 |
| 15640   | SINGLE ROBE HOOK, 2"W x 1-9/16"D   | 50       | 11       | 12.25 | 12.25 |
| 15641   | DOUBLE ROBE HOOK, 4"W x 1-3/4"D  | 50       | 15       | 13.65 | 13.65 |
| 15642   | TOWEL PIN, 2"W x 4-1/2"D   | 50       | 16       | 12.90 | 12.90 |
| 15643   | HAT AND ROBE HOOK, 2"W x 6-1/4"H x 4"D   | 50       | 24       | -     | 34.40 |
| 15646   | TOWEL RING, 5-3/8" DIAMETER x 2-3/8"D  | 50       | 22       | 28.30 | 28.30 |

**BATHROOM ACCESSORIES - CONTEMPORARY SERIES**

MADE IN THE U.S.A

FABRICATED OF TYPE #304, 18-8 ALLOY, STAINLESS STEEL  
FOR HOTEL/MOTEL, HEALTHCARE, HOSPITALS,  
GOVERNMENT & COMMERCIAL PROJECTS.



SCM-P5030



SCM-P5118  
SCM-P5124



SCM-P5500  
SCM-P5860



SCM-P5050  
SCM-P5080



SCM-P5340



SCM-P5360

| 5000 SERIES - CONTEMPORARY |   |                                      |
|----------------------------|---|--------------------------------------|
| ITEM#                      | DESCRIPTION   | DIE CAST ZINC ALLOY<br>CHROME PLATED |
| SCM-P5030                  | DOUBLE ROBE HOOK, 2-3/8"W x 1-3/4"D, CONCEALED SCREW MOUNTING   | 8.00                                 |
| SCM-P5050                  | SINGLE PAPER HOLDER WITH PLASTIC SPRING LOADED CHROME ROLLER, 7-1/2" W X 3" D, CONCEALED SCREW MOUNTING | 17.10                                |
| SCM-P5080                  | SINGLE PAPER HOLDER WITH PLASTIC SPRING LOADED WHITE ROLLER, 7-1/2" W X 3" D, CONCEALED SCREW MOUNTING  | 14.60                                |
| SCM-P5118                  | 18" TOWEL BAR SET (3/4" SQ.), 18" MOUNTING CENTERS X 3" D, CONCEALED SCREW MOUNTING                     | 17.75                                |
| SCM-P5124                  | 24" TOWEL BAR SET (3/4" SQ.), 24" MOUNTING CENTERS X 3" D, CONCEALED SCREW MOUNTING                     | 20.10                                |
| SCM-P5340                  | WALL MOUNTED TOOTHBRUSH/ TUMBLER HOLDER, 4-1/4" W X 3-1/4" D, CONCEALED SCREW MOUNTING                  | 9.80                                 |
| SCM-P5360                  | WALL MOUNTED SOAP HOLDER WITHOUT DRAIN HOLES, 4-1/4" W X 3-1/4" D, CONCEALED SCREW MOUNTING             | 11.70                                |
| SCM-P5500                  | TOWEL RING WITH CLEAR ACRYLIC RING, 6" DIA. X 3-3/8" D, CONCEALED SCREW MOUNTING                        | 14.15                                |
| SCM-P5860                  | TOWEL RING WITH ALUMINUM RING, 6" DIA. X 3-3/8" D, CONCEALED SCREW MOUNTING                             | 16.60                                |



660L-PS



681-PS

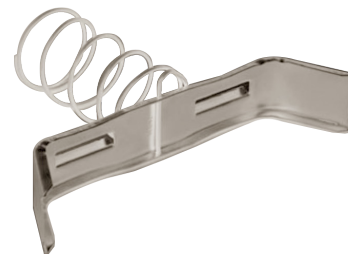

692

| CAL-SERIES-COMMERCIAL LINE |  |     |         |       |
|----------------------------|--|-----|---------|-------|
| ITEM#                      | DESCRIPTION  | QTY | LBS/EA. | PRICE |
| 660L-PS                    | SOAP OR TUMBLER HOLDER WITH METAL LIP, 6-1/4" SQ. X 2" D WALL OPENING 5-1/4" SQ. X 2" D            | 40  | 1       | 44.20 |
| 681-PS                     | PAPER HOLDER - PLASTIC, SPRING LOADED WHITE ROLLER, 6-1/4" SQ. x 2"D WALL OPENING 5-1/4" SQ. x 2"D | 40  | 1       | 44.20 |
| 692                        | MOUNTING CLAMP WITH RETENTION SPRING, 7"W x 1-1/2"H x 4-5/8"D                                      | -   | 1       | 8.35  |



**CAL SERIES - COMMERCIAL ACCESSORY LINE - WASHROOM**

MADE IN THE U.S.A



SCAL-124



SCAL-126



SCAL-200-3016  
SCAL-200-3018

| ITEM#         | DESCRIPTION                                 | DETAIL  | COMPARABLES                          | QTY | LBS/CASE | PRICE/EA. |
|---------------|---|---|--------------------------------------|-----|----------|-----------|
| SCAL-124      | HORIZONTAL WALL-MOUNT LIQUID SOAP DISPENSER | #304 SATIN STAINLESS<br>OVERALL: 8-1/4"W x 4-3/4"H x 3-3/4"D<br>CAPACITY: 40 OUNCES | #2112-BOB<br>#6542-BRAD<br>#0345-ASI | 24  | 17       | 72.45     |
| SCAL-126      | VERTICAL WALL-MOUNT LIQUID SOAP DISPENSER   | #304 SATIN STAINLESS<br>OVERALL: 4-3/4"W x 8-1/4"H x 3-3/4"D<br>CAPACITY: 40 OUNCES | #2112-BOB<br>#6542-BRAD<br>#0345-ASI | 24  | 17       | 72.45     |
| SCAL-200-3016 | WALL-MOUNT UTILITY SHELF                    | #304 SATIN STAINLESS<br>OVERALL: 16"W x 4"H x 6"D                                   | #2112-BOB<br>#6542-BRAD<br>#0345-ASI | 10  | 20       | 98.40     |
| SCAL-200-3018 | WALL-MOUNT UTILITY SHELF                    | #304 SATIN STAINLESS<br>OVERALL: 18"W x 4"H x 6"D                                   | #2112-BOB<br>#6542-BRAD<br>#0345-ASI | 12  | 33       | 109.30    |



SCAL-112



SCAL-113



SCAL-188

| ITEM#    | DESCRIPTION  | DETAIL  | COMPARABLES                            | QTY | LBS/CASE | PRICE/EA. |
|----------|--|---|--|-----|----------|-----------|
| SCAL-112 | WALL-MOUNT DUAL TOILET TISSUE DISPENSER                    | CAST ALUMINUM / PAINT COLOR-SILVER<br>NO WASTE - ROCKING ACTION PLASTIC SPINDLES<br>OVERALL: 13-1/8"W x 1-3/4"H x 4"D<br>CAPACITY: 2 STANDARD ROLLS TOILET TISSUE | #274-BOB<br>#5241-BRAD<br>#02641-1-ASI | 21  | 12       | 34.75     |
| SCAL-113 | WALL-MOUNT DUAL TOILET TISSUE DISPENSER WITH UTILITY SHELF | #304 SATIN STAINLESS<br>OVERALL: 14-3/4"W x 4-1/8"H x 5-1/16"D<br>CAPACITY: 2 STANDARD ROLLS TOILET TISSUE  | #2840-BOB<br>#----BRAD<br>#----ASI     | 12  | 36       | 126.00    |
| SCAL-188 | LOCKING SURFACE-MOUNT DUAL TOILET TISSUE DISPENSER         | #304 SATIN STAINLESS / 2 PLASTIC ROLLERS<br>AUTO DROP DOWN<br>OVERALL: 6"W x 11"H x 5-3/4"D<br>CAPACITY: 2 STANDARD ROLLS TOILET TISSUE                           | #2888-BOB<br>#5402-BRAD<br>#9030-ASI   | 12  | 24       | 170.50    |



SCAL-130



SCAL-170



SCAL-162

| ITEM#    | DESCRIPTION                              | DETAIL   | COMPARABLES                           | QTY | LBS/CASE | PRICE/EA. |
|----------|--|--|---------------------------------------|-----|----------|-----------|
| SCAL-130 | WALL-MOUNT TOILET SEAT COVER DISPENSER   | #304 SATIN STAINLESS<br>OVERALL: 15-5/8"W x 11-1/2"H x 1-7/8"D<br>CAPACITY: 500 SINGLE OR HALF-FOLD SEAT COVERS    | #221-BOB<br>#5831-BRAD<br>#4775M-ASI  | 12  | 15       | 69.65     |
| SCAL-170 | SURFACE MOUNT SANITARY NAPKIN DISPOSAL   | #304 SATIN STAINLESS<br>OVERALL: 8"W x 11"H x 4"D<br>CAPACITY: 1 GALLON RECEPTACLE                                 | #270-BOB<br>#4781-15-BRAD<br>#852-ASI | 12  | 18       | 79.85     |
| SCAL-162 | LOCKING WALL-MOUNT PAPER TOWEL DISPENSER | #304 SATIN STAINLESS<br>OVERALL: 11-1/4"W x 14-1/2"H x 4-1/8"D<br>CAPACITY: 400 C-FOLD/525 MULTI-FOLD PAPER TOWELS | #262-BOB<br>#250-15-BRAD<br>#210-ASI  | 6   | 13       | 90.35     |

## TERMS AND CONDITIONS

### PAYMENT

NET 30 DAYS. All accounts, payable in U.S. funds, are due within 30 days after delivery of goods to Buyer or any common or contract carrier, whichever occurs first. Payments by check, draft, or any mode other than cash is conditional and for Buyer's convenience and is not deemed payment until cash or solvent credit is received and accepted by Seachrome.

### FREIGHT TERMS

All orders FOB Long Beach, CA.

Prepaid freight terms may vary on a product-by-product basis. Please call the factory for freight terms on your particular order.

### MINIMUM ORDER

Minimum order requirement is \$50.00. Any order received for merchandise with a net amount less than \$50.00 will be invoiced at \$50.00, plus any applicable freight charges.

### ORDER REQUIREMENTS

All telephone orders must be confirmed in writing. Seachrome will not assume errors in telephone orders unless written or faxed confirmation is received.

### RETURNS

Returns will only be accepted with written authorization. A 30% restocking charge shall be assessed on all returns. A Return Merchandise Authorization (RMA) number must accompany all returned goods. All returned goods are to be shipped to Seachrome prepaid.

### CLAIMS

Claims for shortage, loss, or damage in transit must be submitted within 48 hours of delivery.

### LIMITED WARRANTY

All Seachrome products will be replaced within one year of shipment if defective in workmanship or material. Seachrome will not be liable for any labor, damage or other expense of any kind incurred in connection with the sale or use of Seachrome products. There is no warranty as to the durability of finishes.

### PRODUCT CARE

The durability of finishes can be preserved by cleaning only with a wet soft cloth or ammonia cleaner. No chlorine cleaners nor abrasives should be used. No guarantee is given as to custom finish items.

### CANCELLATIONS

Orders shall not be cancelled except upon mutual agreement. Orders for custom merchandise cannot be cancelled.

### RIGHT TO REFUSE TO MAKE SHIPMENT

Seller may, at any time, decline to make any shipment or delivery or perform any work except upon receipt of full cash payment in advance.

### ADJUSTMENTS AND BUY REMEDIES

All claims for defective workmanship or material must be made within 30 days after claim arises and must be in writing. Seachrome excludes any warranty of fitness for particular purpose. Buyer's exclusive remedy for the furnishing of materials not conforming to any contract shall be at Seachrome's option to secure the replacement thereof or payment of the claim, which shall not exceed the price of the sale in respect of which such claim is made. In no event shall Seachrome be liable for any special, indirect, incidental or consequential damages.

### DELAYS

Every order is accepted subject to, and Seller is excused for a delay in performance caused by accidents, strikes, riots, labor stoppage, car shortage, climate conditions, unavoidable casualties, or other causes interfering, obstructing or blocking the usual routes of transportation, whether similar or dissimilar to those mentioned above, and no claim for loss or damage shall be allowed by the Buyer in consequence thereof. Seller may rescind any order without liability after acceptance for any of said causes.

### CREDIT POLICY

Initial orders for new accounts are cash or credit card with order. Accounts not paid by the due date will be charged an administrative late charge at the rate of one and one-half percent (1-1/2%) per month, applied against the previous balance after deducting payments and credits received prior to the due date. Buyer acknowledges that Seachrome will incur losses not easily ascertainable in advance in the event of late payment by Buyer, and Buyer agrees to pay such late fee in order to compensate Seachrome for such damages as it may sustain. If it is necessary to employ an attorney or incur any other cost to collect on this account, Buyer shall pay all fees and costs in addition to any amounts due hereunder. Should any portion of Buyer's account become past due, Seachrome shall have the right to declare all invoices due and payable.



### WARNING

If Seachrome products are not installed, operated, and maintained in accordance with the manufacturer's instructions, there is a potential risk of exposure to substances, including nickel, which are known to the State of California to cause cancer, birth defects or reproductive harm. For more information go to [www.P65warnings.ca.gov](http://www.P65warnings.ca.gov).

## Our Commitment To You...

For over 65 years, we've maintained our commitment to quality, safety, and peace of mind in everything we do. Seachrome has combined a world-class manufacturing operation, proficiencies in logistics and supply chain management, a company-wide focus on providing the highest quality in bath accessory designs, along with unparalleled customer service...to satisfy our customers in the OEM, hospitality, institutional, commercial, residential, and assisted-living markets.

Our dedicated approach to innovation in design, and commitment to excellence in production and service, means our work exceeds the standards set for bath accessories that serve special health needs. And our expertise in the guidelines set by the Americans with Disabilities Act is incorporated into our entire Signature Series of grab bars and accessibility seats...where our patented Lift-Assist technology assures safety, security, and compliance with our "Made in the USA" pride in every shower seat we manufacture. We've incorporated this same philosophy into our Silhouette Seat Series...part of our Lifestyle & Wellness® Collection, where sleek and unique designs combine style with stability for residential as well as commercial applications...providing peace of mind for everyone.

We focus on personalized service to every customer... starting with careful attention to detail in concept and design on custom products, through tooling and production, to on-time delivery with every order. In a world where everyone is constantly striving to be better... Seachrome is dedicated to being the best.

We sincerely thank all our employees, our vendors, and our loyal customers for your partnership and support. You have been instrumental in helping us create a thriving and successful company that we all believe in... that inspires us, takes care of us, depends on us, and where everyone feels they belong.

*CA Pulone*

Chris Pulone  
President  
Seachrome Corporation



**SEACHROME™**

 1906 E Dominguez Street., Long Beach, CA 90810

 1 (310) 427-8010 / 1 (800) 955-2476

 1 (310) 427-8005 / 1 (800) 444-3380

 [www.seachrome.com](http://www.seachrome.com)