

SEACHROME

Seachrome Corporation
1906 East Dominguez Street
Long Beach, California 90810
Phone: (800) 955-2476
Fax: (800) 444-3380

Description:

SSR-280225 (HW)
28" x 22-1/2" SHOWER SEAT
Right Hand

Customer:

Customer Part #

01-07-2013

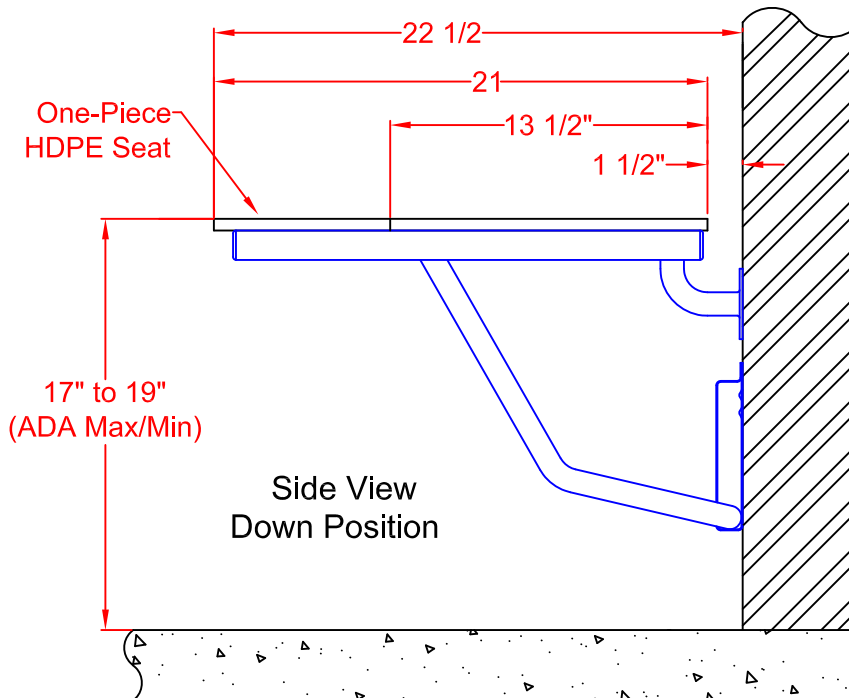
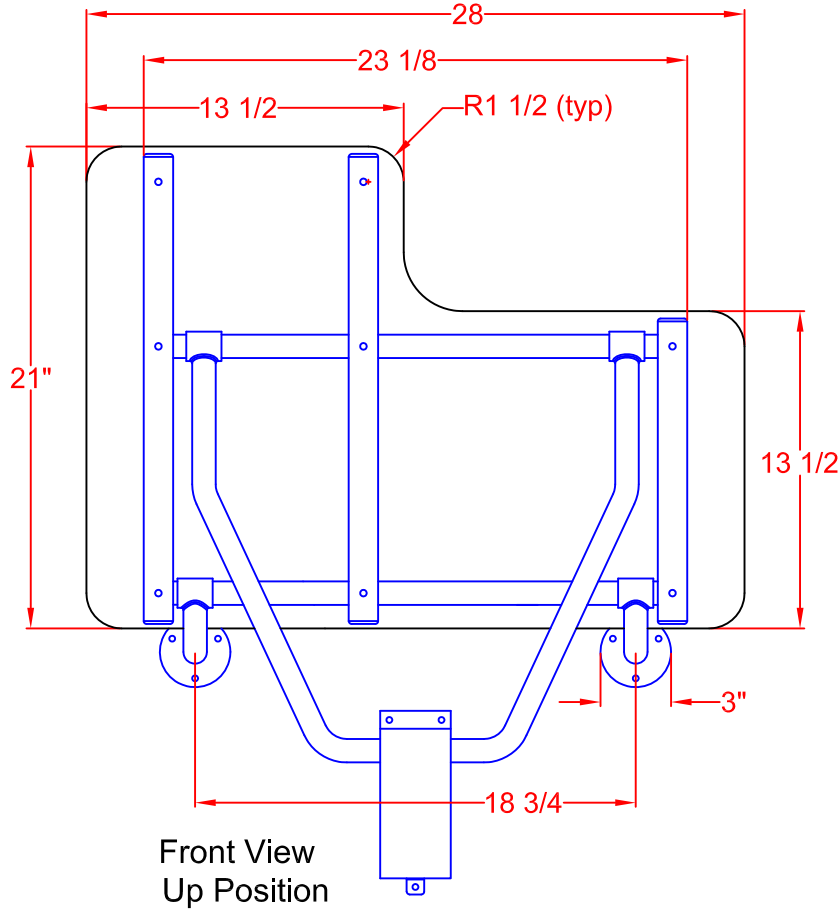

SEACHROME

Seachrome Corporation
1906 East Dominguez Street
Long Beach, California 90810
Phone: (800) 955-2476
Fax: (800) 444-3380

Description:

SSR-280225 (HW)
28" x 22-1/2" SHOWER SEAT
Right Hand

Customer:

Customer Part #

01-07-2013

SHOWER SEAT MODEL #SSR-280225 (HW) Right Hand (White One-Piece HDPE)

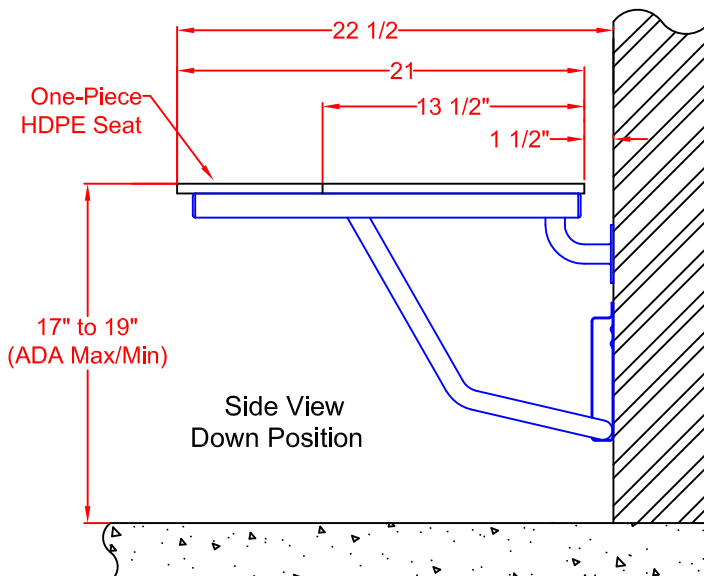
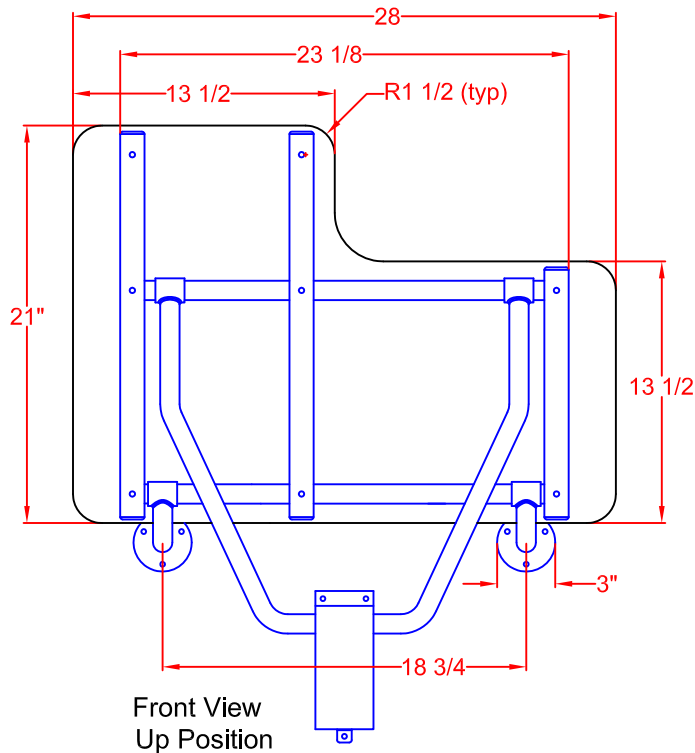

OPERATION:

Constant friction wall mounted "U"- shaped bracket guides leg freely up and down, resulting in a low pressure constant spring action to raise and lower seat. Seat is automatically held in a raised position by the positive stop friction guide bracket.

ARCHITECTURAL SPECIFICATIONS:

Model #SSR-280225 (HW) Folding Bench Seat from Seachrome Corp., Long Beach, California 90810. Phone: (800) 955-2476. Frame: Type 304 (18-8) S.S. tube, 1-1/4" (32mm) x 18ga. (1.2mm) sq. main frame with 1" (25mm) x 18ga. (1.2mm) rd., cross members. Leg: "U"-Shaped yoke of type 304 (18-8) S.S. tubing, 1" (25mm) x 18ga. (1.2mm)rd., with constant friction, wall mounted guide bracket.

MATERIALS:

FRAME: Type 304 (18-8) S.S. tubing, 1-1/4" (32mm) x 18ga. (1.2mm) sq. main frame with 1" (25mm) x 18ga. (1.2mm) rd. cross members.

WALL FLANGES (2): Type 304 (18-8) S.S., 10ga. (3.4mm) x 3" (76mm) Dia. Heliarc welded to 1" (25mm) rd. x 18ga. (1.2mm) 90 degree leg supports, and to 1-1/4" (32mm) rd. x 12ga. (2.7mm) frame hinge couplings. Three mounting holes in each flange.

SUPPORT LEG: "U"- Shaped yoke of type 304 (18-8) S.S. Tube, 1" (25mm) rd. x 18ga. (1.2mm), heliarc welded to 1-1/4" (32mm) rd. x 12ga. (2.7mm) frame hinge couplings.

GUIDE BRACKET: Type 304 (18-8) S.S., 18ga. (1.2mm) x 3" (76mm) wide, constant friction, wall mounted guide bracket, with positive stop for raised position.

SEAT CHOICES: (Designate when ordering)

NW or NA - White (NW) or Almond (NA) Naugahyde covering, 1-1/2" (38mm) foam mounted on 1/2" (13mm) marine plywood.

PW or PT - White (PW) or Teak (PT) Phenolic 1/2" (13mm) x 3" (76mm) slats secured to frame with S.S. screws.

PWS or PTS - White (PW) or Teak (PT) Phenolic 1/2" (13mm) One Piece Solid secured to frame with S.S. screws.

HW- White High Density Polyethylene (HDPE) 1/2" (13mm) thick, secured to frame with S.S. Screws.

SSM- Solid Surface Material 1/2" (13mm) thick, secured to frame with S.S. screws.
(In a variety of colors and patterns).

INSTALLATION:

All Shower Seats must only be installed using suitable fasteners and sufficient in-wall backing materials. A.D.A. mounting height for lowered seat is 17" (432mm) to 19" (482mm).